

Operating Manual
DSC 500
Digital Selective Call
Marine VHF Transceiver

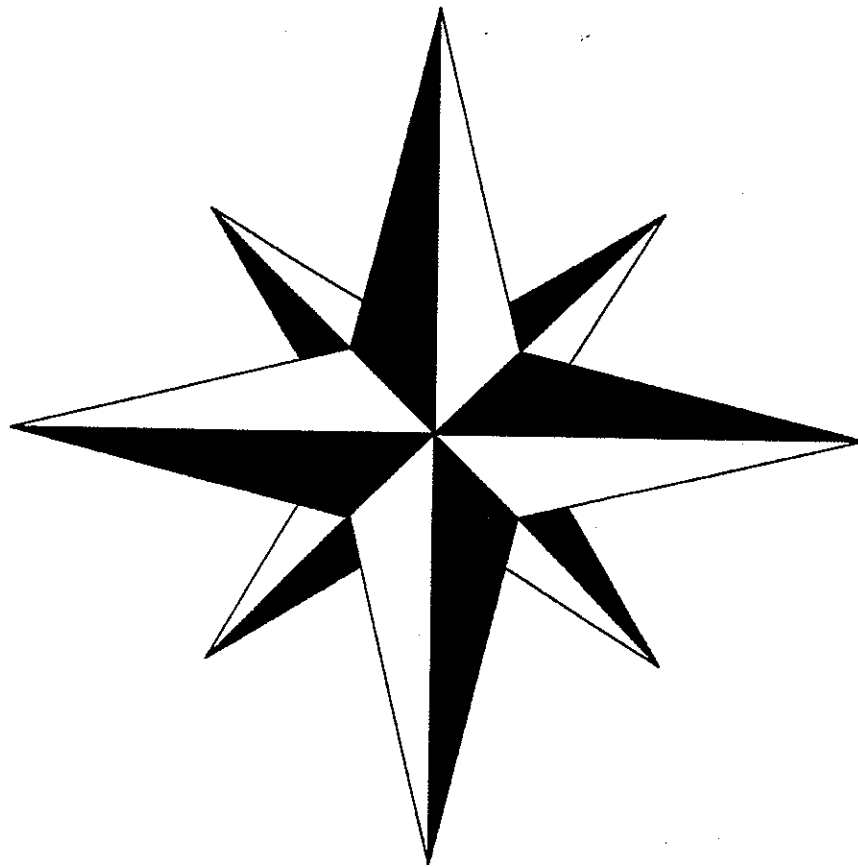

ROSS *Engineering*

12505 Starkey Rd., Suite E, Largo, FL 33773
(813) 536-1226

Web Site: WWW.ROSSDSC.COM

1. The first part of the document is a list of names and addresses.

2. The second part of the document is a list of names and addresses.

3. The third part of the document is a list of names and addresses.

4. The fourth part of the document is a list of names and addresses.

5. The fifth part of the document is a list of names and addresses.

6. The sixth part of the document is a list of names and addresses.

7. The seventh part of the document is a list of names and addresses.

8. The eighth part of the document is a list of names and addresses.

LIMITED WARRANTY POLICY

Your new DSC 500 employs the latest in proven technology and techniques to provide you with a dependable communication system. Although every effort has been made to guard against failures, failures are still possible, both in the equipment aboard your boat and in the shore stations. Also, weather conditions or other interference can develop that seriously degrade signal strength and communication reliability. For these reasons, the manufacturer assumes no liability or responsibility for consequential damages resulting from the use of the DSC 500.

Ross Engineering Co. warrants this product to be free from defects in material and workmanship for a period of two (2) years from the date of purchase from an authorized dealer. This warranty applies to the original purchaser or subsequent owner of such product.

This warranty is limited to repair or replacement, at our option, of any part found to be defective, provided such defect, in our opinion, is not caused by misuse, tampering or normal wear. Any evidence of attempts to gain access to the inside of a unit by unauthorized persons will void this warranty.

Claims under this warranty must be accompanied by proof of purchase.

FLAT RATE REPAIR POLICY

If your DSC 500 should need repair after the the 2 Year Limited Warranty period, it may be returned freight and insurance prepaid, to Ross Engineering Co., 12505-E Starkey Rd., Largo, FL 34643. To assure prompt service, please include \$100.00 service fee, a brief description of problem and complete return address including a phone number in case questions arise about service or delivery. Whenever possible, repairs will be made within two weeks from date of receipt. Repaired units will be returned, surface freight and insurance collect, unless prior arrangements are made. **For units going to destinations outside the continental United States, customs and freight charges are the responsibility of the owner.** Repairs under this policy do not include damage from abuse, neglect, misuse, lightning, fresh or salt water intrusion. Repairs are warranted for 90 days.

COPYRIGHT 1995

Ross Engineering Co., Largo, Florida USA

All rights reserved

This publication may not be reproduced in whole or in part by any means whatsoever without prior written consent of
Ross Engineering Co.



ROSS *Engineering*

12505-E Starkey Rd.
Largo, FL 34643 USA
Phone: (813) 536-1226
Fax: (813) 535-

Setting New Standards In Communications & Navigation

**** Important Notice ****

**YOUR WARRANTY REGISTRATION MUST BE FILLED
OUT AND RETURNED TO ROSS ENGINEERING WITHIN
30 DAYS AFTER DATE OF PURCHASE.
FAILURE TO DO SO COULD RESULT IN REPAIR
CHARGES!**

FOR MORE WARRANTY INFORMATION PLEASE REFER TO YOUR OWNERS MANUAL OR
CONTACT THE SERVICE DEPARTMENT AT ROSS ENGINEERING. 813-536-1226

tw1/26/96



ROSS Engineering

12505-E Starkey Rd.
Largo, FL 34643 USA
Phone: (813) 536-1226
Fax: (813) 535-4248

Setting New Standards In Communications & Navigation

DSC500 WARRANTY REGISTRATION

Radio Serial No. _____ Software Version _____

Vessel Type:

- Power
- Sail
- Other

Propulsion:

- Outboard
- Inboard
- I/O

Vessel Name: _____ Vessel Size: Length _____ Beam _____

Type of VHF Antenna (Make and Model): _____ dB Gain: _____

Type of Navigation Device on Board (Make and Model): _____

Is The Radio Interfaced With the Navigation Device? Yes No

Equipment Installed By: User Dealer Technician

Type of Power Source? _____

Initialization Demonstrated to Purchaser? Yes No

DSC Ship Station Identity Number AND License Application Explained? Yes No

Purchaser's Name: _____

Address _____

City, State & Country _____

Postal Code _____ Phone Number _____

Equipment Received Complete and in Good Condition? Yes No

NOTE

Purchaser's signature required to validate warranty. Photocopies of this form will not be accepted.

Signed _____ Date of Purchase _____

Dealer's Name _____

Address _____

Comments:
tw1/25/96



Contents

GENERAL INFORMATION.....	1
Equipment Description.....	1
Digital Selective Calling.....	1
A Brief History.....	1
Digital Selective Calling Today.....	2
DSC in the Future.....	2
NORMAL COMMUNICATION PRINCIPLES.....	3
A Conventional Voice Call.....	3
A DSC Call.....	3
Scrambler.....	4
License Requirements.....	4
Ships License Application.....	4
Operator's License.....	4
Specifications.....	5
Physical Characteristics.....	5
Power Requirements.....	5
Frequency Range.....	5
Transmitter.....	6
Receiver.....	6
DSC Characteristics.....	7
Data Interface.....	7
Equipment Supplied.....	8
Equipment Recommended but not supplied.....	8
Optional Equipment.....	8
INSTALLATION.....	9
Antenna Mounting.....	9
Transceiver Mounting.....	9
Electrical Connections.....	9
Power and Speaker Cables.....	10
DSC 500 to Personal Computer Wiring.....	11
Microphone Cable.....	12
External Speakers.....	12
NMEA Data Interface.....	13
Grounding Wire.....	13
INTRODUCTION.....	14
Control Functions.....	14
Keypad Functions.....	15
OPERATING PROCEDURES.....	18
Power On and Volume.....	18
Power Off.....	18
Squelch.....	18
Illumination.....	18
Primary Mode.....	18
Changing Channels.....	19
Transmitting.....	20
USA or International Frequencies.....	21
Transmitter Power Setting.....	21
Clock.....	22
Weather.....	22

Contents

EMERGENCY	23
SEND DISTRESS:.....	23
CANCEL DISTR:.....	23
DISTRESS TYPE:.....	24
LAT./LON ENTRY	24
DISTRESS ACKNOWLEDGMENT:.....	24
DISTRESS RELAY:.....	25
DISTRESS LOG:.....	25
Dual Watch.....	26
All Channel Scan	27
Scan Memory.....	27
Scan Review	28
Memory Scan.....	28
Hail	29
Intercom	29
User Setups.....	30
General Procedure	30
Clock.....	31
Viewing Angle	32
User DSC ID.....	32
User Options	34
NMEA Position.....	36
Security Code.....	37
Number People.....	37
DIGITAL SELECTIVE CALL FUNCTIONS	38
Directories	39
DSC Calling Directory	40
DSC Group Calling Directory	40
DSC Coast Station Directory	41
DSC Telephone Directory.....	41
DSC Call Waiting Directory	42
Building Directories	42
New Directory Entry	43
Change or Remove an Existing Entry.....	45
Transfer or Clear from Call Waiting Directory.....	46
Searching Directories	47
DSC Calling	49
To Place a DSC Individual Call.....	49
To Place a DSC Group Call	50
DSC Answering & Call Waiting.....	51
Call received while Idle.....	51
Call received while Busy or Unattended.....	52
Geographic Area Calling.....	53
Scrambler	54
To Place a Scrambled Individual Call.....	54
To Place a Scrambled Group Call.....	55
To Change Scrambler Channels	56
To Cancel Scramble Mode.....	56
To Resume Scramble Mode.....	56

Contents

DSC Standby	57
ALL Ships Call	57
Send Position	58
Receiving a Position	58
Request Position	59
DSC Auto Polling	60
Local and Distant Receiver Modes	61
Reference	62
Operating Techniques	62
Maintenance	62
Memory Battery	63
Fault Code Display	63
Antenna Fault	63
Simplex and Duplex Channels	64
Data Communications Interface	64
NMEA 0183 Sentences Supported	65
NMEA 0183 Specifications	66
NMEA 0183 Sentence Structures	67
USA VHF Marine Channel Assignments	73
International VHF Marine Channel Assignments	75
VHF Marine Weather Channel Assignments	76

GENERAL INFORMATION

Equipment Description

The ROSS DSC 500 is an all-channel Digital Selective Calling FM transceiver operating in the VHF marine frequency range. The transceiver employs the latest radio frequency and microcomputer technology to provide a high performance, reliable communication system for both recreational and commercial mariners. The Digital Selective Calling (DSC) features make the DSC 500 the most advanced marine VHF communication system available. Also, a two way data communications interface allows position reporting when connected to a navigation receiver.

The ROSS DSC 500 system consists of the compact transceiver with microphone, accessories and cables for installation and electrical connection.

The transceiver's front panel is molded of a high impact strength composite material and the housing is a die cast alloy. Both are protected with a tough weather resistant paint finish. The keyboard, display, operating controls and microphone connector are located on the front panel. The power, external speaker and antenna connectors are on the rear. Trunnion mounting fittings are located on each side. The display and keypad are backlighted for night-time use.

The DSC 500 may be mounted using the standard trunnion provided or for through the panel installation, an optional panel mounting adapter is available.

Digital Selective Calling

A BRIEF HISTORY

Digital Selective Calling was conceived by an international committee in the early 1970s. Its purpose was to expedite the handling of traffic in the maritime service by facilitating more efficient calling and to provide a more automated distress and safety system. The international committee, known as the CCIR, is an organization that reports to the ITU which is a part of the United Nations. The CCIR put forth a DSC system proposal which was circulated among nations for comments for many years. Representatives of all countries with salt water coast lines were from both private and public sectors including the FCC. Another key factor in the acceptance of the DSC protocol was that the Safety of Life At Sea (SOLAS) treaty of 1974 and as amended in 1988, required the use of DSC for distress alerting and safety calling. Current international treaties require limited compliance with this treaty starting in 1992. At that time, certain types of vessels will be required to have DSC equipment. Recently, many nations have been expediting the implementation of DSC systems in the VHF arena in hopes of relieving some of the congestion on the voice distress and calling channel, channel 16. DSC helps to solve this problem as it uses channel 70 for its routine calling.

DIGITAL SELECTIVE CALLING TODAY

Your Ross DSC 500 enables you to program into the radio, DSC numbers for other vessels, marinas, bridge tenders and coast stations. DSC Ship Station Identification numbers are issued by the FCC or DOC (Canada) and appropriate communications authorities in other countries. They are like telephone numbers in that they are unique to each station. The DSC 500 has convenient directories for storing and retrieving these numbers either by the name of station or person or by the number. To call another vessel, you would simply select a working channel and then select the vessel's name in the directory and press the ENTER key. The called vessel's radio will "ring" and automatically change to the working channel you selected. Routine conversation may begin immediately. You have been able to completely avoid the congestion on channel 16. Also, you have not added more traffic on channel 16 with your call. If the vessel does not answer your call, its radio will automatically log your call in the "Answer" directory as a call waiting. When your call is recognized, the other vessel can very conveniently return your call.

If you connect your DSC 500 to a navigation receiver such as a Loran-C or GPS, you will be able to quickly give your position to another vessel with a simple digital call. Or, another vessel can request your position from your radio. This makes it very easy to find other vessels and is particularly useful for fleet operators tracking several vessels.

In the unlikely event of an emergency on your boat, you can press one key to broadcast an emergency distress message using the DSC system. This message will be received by all vessels equipped with DSC equipment and will sound alarms on each one. If your DSC radio is connected to a navigation receiver, your vessel's position will also be broadcast, making it easy for others to come to your aid. In the near future, Coast Guard and other Coast Station facilities will be DSC equipped to better receive your distress call and respond with search and rescue equipment. The number of false distress calls should be reduced since the user's ID is broadcast.

Please refer to the DIGITAL SELECTIVE CALL FUNCTIONS section for detailed operating procedures.

DSC IN THE FUTURE.

In the very near future, a network of Public Coast Stations will be equipped to receive VHF DSC calls and to offer the mariner completely automatic telephone facilities.

The DSC 500 includes a special telephone directory for this purpose. This feature allows you to enter the regular telephone numbers of people you need to call from your vessel. Selecting one of these numbers places a DSC call to a coast station. The coast station equipment will change your DSC 500 to the coast station's working channel and automatically dial the phone number.

Please refer to the Telephone mode procedures in the DIGITAL SELECTIVE CALL FUNCTIONS section for details.

NORMAL COMMUNICATION PRINCIPLES

Proper operation and courteous behavior in the operation of VHF communication equipment is essential in deriving the maximum benefit from the many services available to the mariner. Although the DSC 500 has many advanced features to avoid channel congestion and improve communication effectiveness, it is still necessary to observe the basic communication rules.

In its most basic functions, DSC 500 is similar in operation to other VHF radios with which you may be familiar.

A Conventional Voice Call

- Select channel 16 and wait for the channel to clear.
- Establish contact with the desired vessel.
- Agree on a working channel and sign off on channel 16.
- Select the agreed upon working channel and wait for the channel to clear.
- Establish contact on the working channel and continue the conversation.
- Sign off of the working channel and resume watch on channel 16 or other channel where a call might be expected.

Digital Selective Calling offers a better way.

A DSC Call

- Select a desired working channel and wait for the channel to clear.
- Enter the DSC mode and select the desired party from the directory.
- Place the call by pressing one button.
- When DSC contact is confirmed, establish voice contact and converse.
- Sign off of the working channel and resume watch on channel 16. Your DSC 500 receives DSC calls on channel 70 while monitoring any channel.

Scrambler

The scrambler feature of your DSC 500 allows private conversation on normal working channels. Communication between two or more DSC 500s will be loud and clear while all others who may be monitoring the channel hear only unintelligible garble. Even other DSC 500s are not be able to listen in unless specifically invited. To thwart even a serious eavesdropper, the DSC 500 uses a pseudo-random selection of over a million scramble codes and changes them twice every second.

Please refer to the Scrambler mode procedures in the DIGITAL SELECTIVE CALL FUNCTIONS section for details.

License Requirements

Most countries require that a radio station be licensed prior to operation. Radio stations aboard US flag vessels are licensed by the Federal Communications Commission (FCC). Licenses may be issued to United States citizens. Recreational boaters are not required to keep a copy of the FCC rules. However, they are responsible for knowledge and compliance with the FCC rules.

Ships License Application

A marine VHF station license for US vessels is obtained by submitting FCC form 506A to the FCC. Effective May 21, 1990 a fee must be included with the application. Form 506A includes a Temporary Operating Authorization which will allow you to use your DSC 500 while the FCC is processing your application. Be sure to check the Yes box on line 20 of form 506A to request your Mobile Service Identity number for DSC use. Current licensing standards can be obtained at any FCC field office.

Please refer to License Application Information and FCC form 506A included with your DSC 500.

Operator's License

If you plan to dock in a foreign port, or are leaving a foreign port to dock in a US port you must have a RESTRICTED RADIOTELEPHONE OPERATOR PERMIT to operate a VHF marine radio. However, if you merely plan to sail in domestic or international waters without docking in any foreign ports, and you have only a VHF radio, you do not need an operator's permit. To obtain a restricted radiotelephone operator's permit, file form 753. There is no test required and the permit is good for life. Effective May 21, 1990 a fee is charged.

Specifications

Type Certification: USA: FCC, Parts 15, 80, 80K, 80R, 80S, 80T, 80U, 80.1101(c)(2), notes CP, GM.
IMO: Resolution A.609(15)
ITU: Recommendation ITU-R M.493-7, Class A
Recommendation ITU-R M.541-6.
VTS: Recommendation ITU-R M.825
Recommendation ITU-R M.1084
Canada: DOC, Cat C, L, V.
Europe (EC): ETS 300-162
Others: Russia, Greece, Turkey, Singapore, China and others.

Physical Characteristics:

Width: 6.38 inches.
Height: 3.25 inches.
Length: 7.25 inches.
Weight: 5.60 pounds.

Temperature Range: -20 °C to +50 °C.
-4 °F to +122 °F.

Power Requirements: 11 - 18 Vdc, 13.8 Vdc nominal.
0.6 Amps receive.
6 Amps transmit.
Floating ground.

Frequency Range:

Primary channels: 156.025 - 157.425 MHz, transmit.
156.025 - 163.275 MHz, receive.

Programmable* channels: 156.000 - 159.175 MHz, transmit.
156.025 - 163.775 MHz, receive.

Channels: 57 standard USA or ITU Appendix 18 International, 10 weather and 42 programmable* channels (29-59 & 89-99).

* Programmable channels can be installed only by authorized dealers.

Display: 1 in. x 2.5 in. alphanumeric LCD, supertwist
80 x 32 dot matrix.

Illumination:	Display and keypad, three levels and Off.
RF Output Connector:	SO-239, UHF(f).
Mating Antenna Connector:	PL-259, UHF(m).
Transmitter:	
Output Power:	1 or 25 Watts selectable.
Frequency Stability:	0.0005% from -20 °C to +50 °C.
Spurious Emissions:	-70 dB @ 25 Watts, -56 dB @ 1 Watt.
Output Impedance:	50 Ohms.
Antenna Mismatch:	Built in VSWR protection and fault warning display.
Modulation:	FM, 5 KHz max. deviation.
Audio:	Less than 5% distortion at 3 KHz deviation, +6 dB per octave pre-emphasis.
Hum and Noise:	-37 dB.
Receiver:	
Sensitivity:	0.25 μ V max. for 12 dB SINAD.
Adjacent Channel Rejection:	-80 dB.
Intermodulation Rejection:	-80 dB.
Spurious Response:	-80 dB.
Modulation Acceptance Bandwidth:	\pm 7.5 kHz.
Spurious Emissions:	Less than 316 μ Volts.
Squelch Threshold:	0.20 μ Volts max.
Audio:	-6 dB per octave deemphasis. Less than 10% distortion at 6.5 Watts.

Hum and Noise: -40 dB.

Audio Power: 8 Watts into internal 8 Ohm speaker with less than 10% distortion.

Hail and Intercom: 20 Watts into external 4 Ohm speaker with less than 10% distortion @ 14.5 Vdc input.

DSC Characteristics

Compliance: General GMDSS (All Versions):
 Recommendation ITU-R M.493-7, Class A
 Recommendation ITU-R M.541-6.
 FCC Part 80.1101(c)(2), CP,GM
 IMO Resolution A.609(15).
VTS/ADS Versions:
 Recommendation ITU-R M.825.
 Recommendation ITU-R M.1084.

Frequency: 156.525 MHz (Channel 70).

DSC Transmitter Power: 25 Watts.

Directory Entries:

Calling Ship to Ship: 200.
 Calling Public Coast Station: 50.
 Calls Waiting: 100.
 Telephone Calling: 200.
 Group Calling: 50.
 Distress Log 20.

Data Interface

Compliance: NMEA 0183.

Sentences supported:

Listen: \$xxGLL, \$xxGTD, \$xxAPA, \$xxAPB,
 \$xxRMA, \$xxRMB, \$GPRMC, \$PKMLC,
 \$PKMAP, \$xxGGA, \$xxVTG.

Talk: \$xxWPL, \$xxBWC, \$PREWPT, \$PRERV.

Equipment Supplied

- DSC 500 transceiver.
- Standard trunnion mount and knobs.
- Microphone and mounting clip.
- Power cable.
- Speaker cable.
- Operating manual.
- Mounting hardware assortment.

Equipment Recommended but not supplied

- Marine VHF antenna.
- Marine antenna mount.
- Mini clamshell covers.
- Sealant.

Optional Equipment

- External speaker.
- Hail speaker.
- Intercom speaker.
- Panel mounting adapter, DSC 500, P/N 001-0019-015.
- David Clark P.T.T. Headset.

INSTALLATION

Your ROSS DSC 500 system has been designed to withstand the rigors of the marine environment and if carefully installed should provide long and trouble free service. Although the receiver is sealed, it should be located in an area with some protection from driven spray and moving objects that could strike the unit. Direct sunlight will not damage the DSC 500 but some shade will reduce reflections on the display.

Antenna Mounting

Installation of a VHF antenna is as important to reliable communications as the transceiver itself. It is recommended that a high quality antenna be purchased from an established source. In general, antennas should be located as high as practical on the vessel and separated as much as possible from other antennas and vertical structures. The antenna should be installed in accordance with the manufacturer's instructions with particular attention to cable routing and connector installation. All connections must be bright, tight and protected from moisture.

Transceiver Mounting

The ROSS DSC 500 transceiver is compact to permit easy installation on crowded consoles or overhead locations. It should be positioned with an unobstructed view of the display and easy access to the keypad and controls. The selected location should also take into account the routing of the microphone cable both when in use and when stowed.

NOTE

In order to provide the best fidelity at high volume settings, your DSC 500 uses a speaker with a strong magnet. Observe your compass when selecting the transceiver mounting location. Choose a location with minimum effect on compass accuracy.

The minimum safe distance will vary according to the relative position and orientation of the compass and the DSC 500.

The transceiver may be mounted using the standard trunion provided or with an optional panel mounting adapter which allows the DSC 500 to be mounted through an instrument panel or bulkhead.

Once the location is selected, use the trunion as a template to mark the locations of the holes for the mounting screws. Carefully drill four holes, slightly undersized, into the mounting surface. Apply sealant around the holes, position the trunion, install the stainless steel screws and tighten securely.

If it is desired to install the DSC 500 through an instrument panel or bulkhead, the optional panel mounting adapter may be used.

Electrical Connections

Two cable assemblies are supplied. One for 12Vdc power and the other for external speakers and data interface. The power cable has two large conductors and the speaker cable has ten smaller conductors. Both cables have printed markers near the ends to identify their purpose or polarity.

The ROSS DSC 500 should be connected to the ship's 12Vdc main power buss and protected with a 10 Amp fuse or circuit breaker. The power cable supplied with your transceiver is approximately 6 ft. long with **large** red and black leads. When transmitting, the transceiver draws 6 amps. THE VOLTAGE LOSS IN SMALLER WIRES REDUCES THE TRANSMITTER OUTPUT POWER. IT IS IMPORTANT THAT THE DC POWER BUSS, TO WHICH THE DSC 500 IS CONNECTED, HAS SUFFICIENTLY LARGE WIRES RUNNING TO THE SHIP'S BATTERY. Also, the longer the run, the larger the wires must be. For most small vessels the wires must be no smaller than # 12 AWG.

Connect the **large** Red power lead, with a fuse or circuit breaker, to the Positive (+) terminal on the 12Vdc power buss. Connect the **large** Black power lead to the Negative (-) terminal. Observe proper polarity. The DSC 500 is internally protected against reversed polarity and it will not operate with the power connections reversed. Both power leads should be shortened as much as practical to avoid voltage drop.

Power and Speaker Cables

Both the power and speaker cables are supplied prewired. Wiring information is provided for reference.

Power cable:



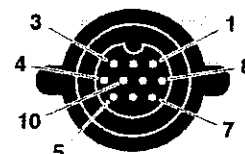

Cable Connector
Front View

Speaker cable:



Cable Connector
Front View

The speaker cable also includes conductors for connecting an optional data interface between the DSC 500 and a navigation receiver.

Pin No.	Function	Color	Destination
2	Ext. Speaker	Gray	
8	Ext. Speaker	Pink	
1	Intercom	Brown	
3	Intercom	Blue	
9	Hail	White	
10	Hail	Green	
4	Data out, Lo	Black	connect to Nav data in, Lo
7	Data out, Hi	Violet	connect to Nav data in, Hi
6	Data in, Hi	Yellow	connect to Nav data out, Hi
5	Data in, Lo	Orange	connect to Nav data out, Lo

Speaker and Data Cable Wiring

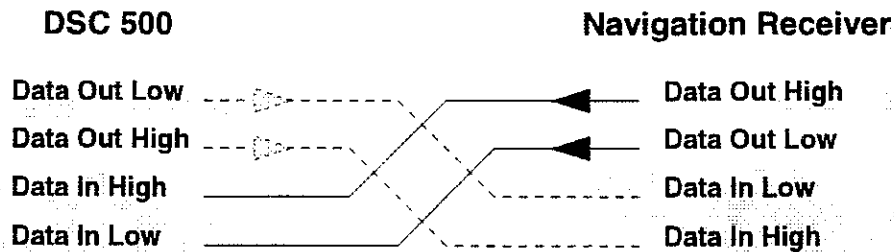

Data Interface Connection

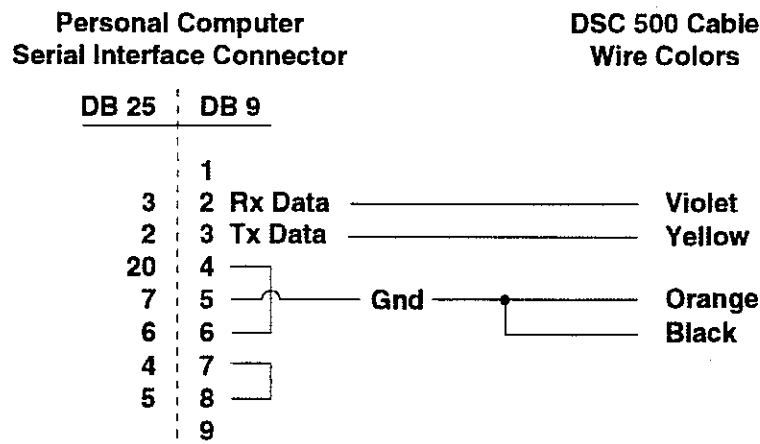

DSC 500 to Personal Computer Wiring

Microphone Cable

The microphone connector is supplied prewired. Wiring information is provided for reference.

Pin No.	Function
1	Privacy.
2	Data Out.
3	Data In.
4	Serial Clock.
5	Headphone Audio.
6	Ground.
7	+8 Vdc.
8	Microphone Audio and Push to Talk.

External Speakers

In addition to the internal speaker, there are three different optional speakers that may be connected to the DSC 500: an external speaker, the hail speaker and the remote station intercom speaker. Each optional speaker is for a single purpose and connections for each are provided in the speaker cable. The external speaker is wired in parallel with the transceiver's internal speaker which is used for all normal communications and for listening to audio from the intercom and hail remote speaker locations. Connecting an external speaker does not disable the internal speaker. The optional hail and intercom speakers are used as both a speaker and microphone which permits two way communication from either remote location.

CAUTION

When installing external speakers, make sure the power is disconnected and that connections are secure and properly insulated. **Shorting any lead to ground, to the speaker frame or to another wire will damage the transceiver.**

External speakers and their enclosures should be chosen according to their intended use and their mounting location. The hail speaker may have either an 8 Ohm 10 Watt or 4 Ohm 20 Watt rating. Since hail speakers are usually installed in exposed locations, a weatherproof unit should be chosen. For the external speaker and the intercom speaker, an 8 Ohm 10 Watt unit with appropriate enclosure is recommended.

NMEA Data Interface

One of the features of the digital selective calling capabilities of the DSC 500 is its ability to send and receive vessel position coordinates. The position coordinates transmitted by the DSC 500 must come from a navigation receiver via the data interface. When receiving position coordinates, a message must have been transmitted by another DSC radio with its own navigation receiver. Once received, the position coordinates of another vessel may be either displayed by the DSC 500 or transferred, again via the data interface, to a navigation receiver as a waypoint. Refer to the POSITION TRANSFER section of this manual for more detailed information.

The electrical connections for the data interface are included in the speaker cable. Refer to the speaker and data interface wiring diagram above.

Consult the manual or the manufacturer of your navigation receiver to determine the proper data interface connections.

Most, if not all, navigation receivers have position data output capability but few have data input capability. Also, some navigation receivers do not provide Lat./Lon coordinates to the data interface when navigating in TD mode. The DSC protocol specification expects Lat./Lon coordinates.

The data interface is a user optional feature and is not required for normal operation of the radio.

Please see the REFERENCE section of this manual for technical details of the NMEA Data Interface.

Grounding Wire

A bundle of green grounding wire is supplied with the DSC 500 VHF Transceiver. This will aid in protection from nearby lightning strikes, which may produce fields strong enough to effect electronic equipment. This effort is being made to reduce damage from lightning and the likelihood of a lightning strike. However, *Ross Engineering* makes no warranty with respect to lightning and/or its effects, due to the highly unpredictable nature of lightning which we categorize as an act of God.

The grounding wire is 10 meters (33 ft) of AWG 16 green stranded wire with a female tab connector on one end. The installer must prepare the other end for connection to an appropriate grounding point. A male tab terminal is provided on the antenna connector located on the rear of the transceiver.

Installation of the ground wire is accomplished by mating the tab terminals at the transceiver and running the ground wire to a seawater ground. If the vessel has a bonding system for lightning protection, the ground wire may be connected to a bonding point. If a bonding system is not available, the ground wire should be connected to a seawater ground either at a Dyna-Plate™ or engine block. The better the ground to seawater the better the protection.

**DO NOT CONNECT THE GROUND WIRE TO
THE DC POWER BUSS AT ANY POINT OTHER THAN
THE ENGINE BLOCK OR WHERE THE BATTERY
CONNECTS TO A SEAWATER GROUND**

INTRODUCTION

The ROSS DSC 500, while being an advanced VHF communication transceiver, is still easy to operate. Channel selection and choice of operating modes are selected from the keypad. The squelch and volume controls provide smooth independent control for each of their functions. A full alphanumeric display presents complete information regarding the active status of the DSC 500 both during normal operation and when other modes are active. The display also presents plain language prompts and warnings to aid in the use of advanced features.

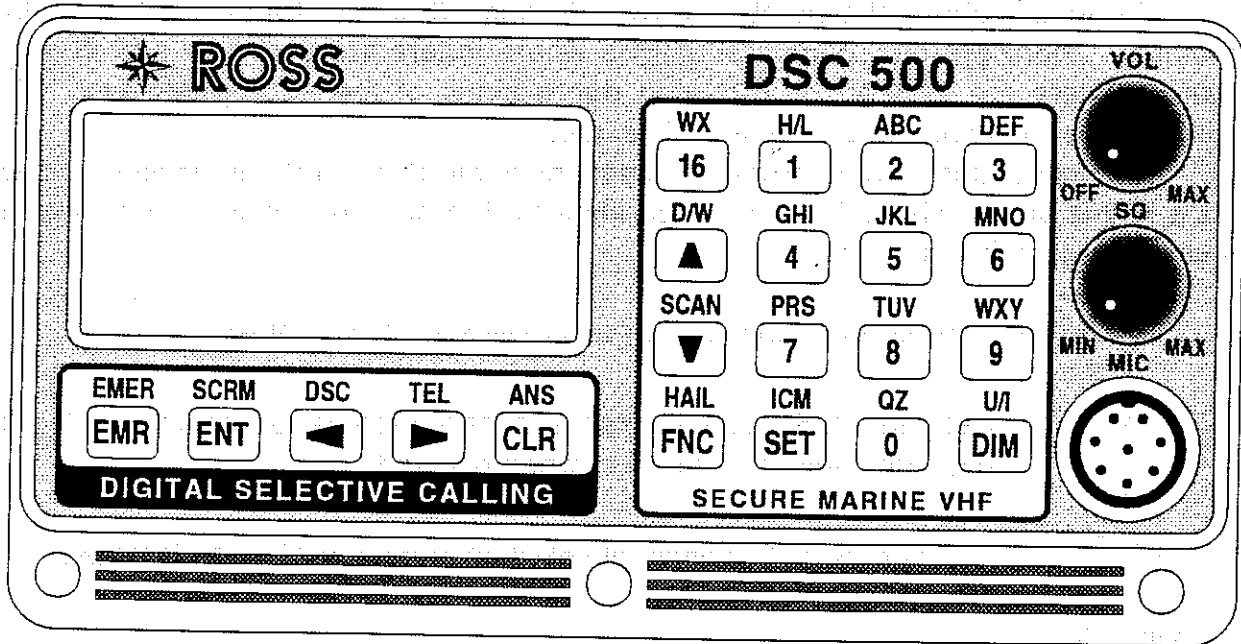

FRONT PANEL

Control Functions



Turns the DSC 500 On and Off and adjusts the speaker volume level. Also adjusts the Hail and Intercom output level.



Sets the threshold level of received signals that will produce audio output from the speaker.



Microphone Push To Talk button. Press the Push To Talk button to transmit. Release button to receive. A Transmit timer limits continuous transmissions to 5 minutes.

Keypad Functions

All of the keys except the **EMR** key on the DSC 500 keypad serve two functions. The primary function for each key is shown on the face of the key and is invoked by pressing the individual key. The second function for a key is printed on the front panel just above the key. To invoke most second functions, press the **FNC** key and then press the key just below the function desired. As an example, pressing **16**

selects channel 16 and pressing **FNC** **WX 16** selects the Weather mode.

The letters above the number keys, 2 through 0 cannot be invoked using this method. There are only certain situations where letters are accepted and in those cases, letters are entered by repeated depressions of the appropriate key. The procedure is described later in a specific example.

Throughout this manual, when key sequences are described, the desired function for a key is shown shaded. Also, when invoking the primary function for a key, the second function is not shown.

The primary and second functions for each key are shown below.

16 Sets the DSC 500 to transmit and receive on channel 16 and overrides any other function when pressed.

1 - **0** Number keys. For channel selection and entry of numeric values.

ABC 2 ~ **QZ 0** Letter keys. For entry of names into directories.

▲ Up arrow key. May be used to select the next higher channel number or move selection bar upward in menus.

▼ Down arrow key. May be used to select the next lower channel number or move selection bar downward in menus.

WX 16 Weather. Allows the 10 weather channels to be selected individually or scanned.

UI DIM Selects USA or International frequency set.

SCAN ▼ Displays Scan Selection menu. Choose Memory Scan, All Channels, or Scan Review.



Dual Watch. Allows any two channels to be selected and monitored simultaneously.



Selects high (25 W) or low (1 W) transmit power. Also selects local or distance receive mode.



Activates the Hail mode. Remote hail speaker required.



Activates the Intercom mode. Remote station speaker required.



Selects any of the four backlight levels; Low, Medium, High and Off.



Displays User Setups menu. Choose from Clock, Viewing Angle, User DSC ID, User Options, NMEA Position and Security Code.



Enter. Used to complete selections and terminate multiple key entries. Enter displayed channel into Memory Scan memory.



Displays the *scrambler menu* Scrambler selection menu. Choose Individual or Group scramble or Search for directory entry.



Right arrow. Used to change pages in multiple page menus and advance the entry position when entering or editing user data.



Left arrow. Used to change pages in multiple page menus and backspace the entry position when entering or editing user data.



Displays the DSC Calling and several other menus regarding DSC operations. Use arrow keys to make selections.



Displays the Telephone and Coast Station menus. Choose any existing entry, New Entry or Search for individual telephone numbers and coast station DSC ID numbers.



Clear key. Clears erroneous entries. Clears displayed channel from Memory Scan memory. Stops call ringing.



Answer. Displays the Call Waiting menu. Select any entry to respond.



Function key. Selects the second function for a key. The second function is shown above the key. Does not select the letters above number keys 2 through 0.



Emergency key. Displays the Emergency menu. When held for 5 seconds, the emergency message is transmitted on channel 70.

SOUNDS

Sounds are used to annunciate actions and to alert the user to invalid entries or to messages that may require attention. The beep sounded during self test is typical of the pitch for most sounds. The number of beeps and the interval between beeps is used to produce the different sounds.

The sounds and their meanings are:

Two second steady beep:	Self Test.
One short beep:	Valid key entry, accepted.
Two short beeps:	End of Scan Review and directory lists.
Three short beeps:	Invalid key entry, incomplete DSC call.
Four short beeps:	Successful DSC call.
Repetitive short Hi/Lo beeps:	DSC ring, call received.
Continuous alternating Hi/Lo tone:	Distress message, sent or received.
Repetitive short beeps:	Certain keys held continuously.

All sounds, except the distress tone, may be turned Off or their volume adjusted via settings made in the User Setups mode. Please see the USER SETUPS mode description for the procedure.

OPERATING PROCEDURES

Basic Functions

POWER On and VOLUME

Rotate the  knob clockwise. The beeper sounds and the self test display appears for approximately two seconds. Also, the display and keypad illuminates briefly. After self test is complete, the Primary mode display appears indicating the channel in use when the transceiver was last turned Off. Rotate the knob further clockwise to adjust the audio output level. If a self test fails, a message describing the failure will be displayed. Refer to the discussion of FAULTS and FAILURES in the REFERENCE section.

POWER Off

Rotate the  knob counterclockwise until it clicks. The display becomes blank and the transceiver does not receive any calls. Memory is protected by an internal battery.

SQUELCH

Rotate the  knob counterclockwise until background noise is heard. Then, readjust the knob clockwise until slightly beyond the point where noise is muted.

ILLUMINATION

The display and keypad are backlit for night time use. There are four illumination levels including Off. The last used illumination level is not remembered when the DSC 500 is turned Off. The lights are Off at Power On.

Press the **DIM** key repeatedly to select Low, Medium, Bright or Off.

PRIMARY MODE

The Primary Mode is the basic communication mode of the transceiver. Operations in this mode are basically the same as using any marine VHF radio. In voice contacts, both calling and routine communication use the Primary Mode. Even when a DSC call is placed or received, the routine communications that follow the DSC operations use the Primary Mode.

In the Primary Mode Display the active channel number appears in large digits on the left-hand side of the display. A bar graph representing received signal strength or transmitter output power is on the right-hand side. XMIT appears in the center of the display when transmitting. Other information presented is time of day, power setting HIGH or LOW, the frequency set USA or INTL, and MEM if the channel has been entered into the Memory Scan list. If the Local receive mode is selected, a reverse video letter L appears in the lower line of the display. The lower line of the display, where time normally appears, may also display messages pertaining to DSC calls and operating status.

The Primary mode may be selected in several ways. The simplest way is to press the **16** key. Any function, active or pending, is canceled and the Primary mode display appears with channel 16 selected.

Another way, press two channel number keys. In all modes, except open edits where alphanumeric entry is expected, pressing two channel number keys invokes the Primary mode and selects the entered channel number. A three beep tone sounds if an invalid channel number is entered.

Still another way is to press the function key(s) for the current active mode again.

For example, to select the Hail mode, press the **FNC** **HAIL FNC** keys. The HAIL display appears. Now, to cancel the Hail mode, press the **FNC** **HAIL FNC** keys again. The Primary mode display appears.

CHANGING CHANNELS

To select the calling and safety channel . . .

Press the **16** key. The Primary mode display appear with channel 16 selected as the working channel.

To select a working channel . . .

Press the **▲** or **▼** key or two number keys for the desired channel when the Primary mode is active. The three beep error tone sounds if an invalid channel number is entered.

If the transceiver has another mode active, the scan menu for example, two options are available to select an new channel. Pressing the function keys for the active mode returns to the Primary mode with the current working channel active. Then press the arrow keys or two number keys to select the desired channel. Also, in most menu display modes, pressing two number keys corresponding to a desired channel changes to the Primary mode with the new channel active.

The DSC 500 may also be programmed to operate on other channels and frequencies. A list of valid channel numbers and the corresponding frequencies appears in the REFERENCE section of this manual. Operation on these channels can only be enabled by an Authorized Ross Servicing Dealer provided authorization to use the channel and frequency have been obtained from the governing agency. In the USA, authorization must be obtained from the FCC prior to enabling these additional channels.

TRANSMITTING

To transmit, hold the microphone near your lips and press the Push To Talk button on the microphone. Speak slowly and clearly in a normal voice directly into the microphone. The XMIT annunciator appearing in the display verifies that transmission is taking place. The bargraph on the right-hand side of the display shows the relative power being transmitted. Release the Push To Talk button at the end of the transmission. Transmission is automatically prevented on weather channels.

NOTE

The transmitter has an automatic timer which limits continuous transmissions to five minutes, thereby preventing channel blockage from a stuck microphone button. An alarm message is displayed until the Push To Talk button is released following the five minute period.

NOTE

Channel 70, the DSC communication channel, is listen only. No voice transmissions are allowed. The transmitter will not operate if the Push To Talk button is pressed when Channel 70 is selected.

If a bad antenna condition is detected, the alarm message ANT FAULT appears in the lower line of the display as long as transmission is attempted. Note that the transceiver continues to attempt transmission even though the alarm message appears. Refer to the troubleshooting guide in the REFERENCE section of this manual for tips on what to do in this situation.

USA or INTERNATIONAL FREQUENCIES

The DSC 500 may be operated on either USA or International frequencies. The current selection appears in the Primary mode display.

To change the current frequency set . . .

Press the **FNC** **U/I** **DIM** keys while the Primary mode is active. The annunciator toggles between USA and INTL each time the keys are pressed.

Tables are included in the Reference section of this manual which list the channel allocation for both USA and International frequencies. Primarily, the difference between the two frequency sets is whether simplex or duplex frequencies are assigned to some channels.

TRANSMITTER POWER SETTING

The transmitter may be operated at either 25 Watts (high power) or 1 Watt (low power) output. The current power setting, HIGH or LOW, appears in the Primary mode display. When the channel is changed, the default high power setting is selected except for certain channels restricted to the low power setting as described in the Channel Assignment tables in the REFERENCE section of this manual. The power level for those channels will be set automatically when selected. Also, when communicating on any working channel over short distances, the considerate user will select the low power setting.

To change the current power setting . . .

Select the Primary mode.

Press the **FNC** **HL** **1** keys. The HI/LOW SELECT menu appears in the display.

Press the **▲** or **▼** key to position the selection bar on TX POWER. Observe that the setting appearing the display is the opposite of the current setting.

Press the **ENT** key. The Primary mode display appears with the new power setting.

Pressing any key other than the **ENT** key exits the HI/LOW SELECT menu without changing the power setting.

The transmit power control for channels 13 and 67 operate differently than all others. These channels are normally LOW power and the power setting cannot be

changed. To transmit on HIGH power, the **FNC** **HL** **1** keys must be pressed and held while the microphone Push To Talk button is pressed. The HIGH annunciator appears in the display while transmitting at 25 watts.

CLOCK

Time of day normally appears in the lower line of the Primary mode display. The time may be displayed in either AM/PM or 24 hour format and local or UTC depending upon the selection made in the Clock menu of the User Setup mode.

The Clock mode provides more information including time of day in hours, minutes and seconds, AM/PM, local time or UTC, the date and the day of the week. Please see User Setup mode for selection procedure.

WEATHER

The Weather mode allows the DSC 500 to monitor ten weather broadcast channels. These are receive only channels so the transmitter is disabled.

Press the **FNC** **WX 16** keys to receive recorded weather broadcasts. The WEATHER display will appear and the last used channel will be selected.

Press the **▲** or **▼** key or a number key to select a different weather channel.

Press the **FNC** **SCAN** keys to scan all weather channels. When activity is detected on a channel, the scan will stop. Three seconds after activity ceases the scan will resume. Since weather channels are usually continuous recordings, scanning may not resume automatically for some time.

Press the **▲** key to force scanning to continue.

To stop scanning and return to a weather channel . . .

Press **FNC** **SCAN** again.



To return to the Primary mode . . .

Press the **FNC** **WX 16** keys.

To select any other mode, press the function key(s) for that mode.





EMERGENCY

The Emergency mode may be used to send a distress call. The distress call automatically includes the vessel's DSC call sign and Lat./Lon position. The vessel's position can be sent only if the transceiver is properly connected to an operating navigation receiver.



To access the Emergency functions, press the  key, or by pressing the  key and the  key. The Menu options include:

- SEND DISTRESS
- CANCEL DISTR
- DISTRESS TYPE
- LAT/LON ENTRY
- DISTRESS ACK
- DISTRESS RELAY
- DISTRESS LOG



SEND DISTRESS:

To send a distress call, first go to the Distress Menu by pressing the  key. The menu selection by default is the "SEND DISTRESS" option. From the Distress Menu, press and hold the  key or the  key. The Send Distress display prompts the user to "HOLD KEY TO SEND DISTRESS" and has a countdown indicator on the bottom line displaying the number of seconds until transmission of the distress call. The  key or  key must be held for 5 seconds before the Distress Call will be transmitted. If the key is released before the distress call is sent the transmit timer will restart at 5 seconds.

CANCEL DISTR:

If a distress call is made by mistake, the Cancel Distress function can be used to "Cancel" the active distress. Use the  and  Arrow keys to select "CANCEL DISTR" and press the  key. This function is not available if there is not an active distress from your radio. The Cancel distress function sends out a Distress Acknowledgment with its DSC ID as the source and destination.



DISTRESS TYPE:

To specify the type of distress, select the Distress Type menu option with the  and  Arrow keys, and press the  key. The menu options are:

FIRE
FLOODING
COLLISION
GROUNDING
CAPSIZING
SINKING
ADRIFT
UNDESIGNATED (default if none is selected)
ABANDONING
PIRACY
MAN OVERBOARD





Select the type of distress with the  and  arrow keys, and press the  key. The selected distress type will remain active until the radio is turned off.

LAT./LON ENTRY

Select the "LAT./LON ENTRY" option from the main distress menu with the  and  arrow keys, and press the  key. If the DSC500 has no position, then the latitude on line 3 and the longitude on line 4 will be blank. Enter the latitude and longitude for the position of the radio. To enter the hemisphere, press the corresponding key where the alpha character is located.





Note that this option is not available if the DSC500 has a valid position from a navigational device.

DISTRESS ACKNOWLEDGMENT:



To acknowledge a distress call that a DSC500 radio has received, select the "DISTRESS ACK" option from the main distress menu with the  and  arrow key, and press the  key. The next display will be the "DISTRESS LOG" (see distress log below). Select the distress log entry, which corresponds to the Distress Call that is to be acknowledged, and press the  key.

Note that a distress call can not be acknowledged by a DSC500 for the first 80 seconds after receiving the call. This allows time for shore base stations to respond to the distress call.

DISTRESS RELAY:





To relay a distress call that the DSC500 has received, select "DISTR RELAY" from the main distress menu with the  and  arrow keys, and press  key. The distress log will be displayed. Select the distress log entry, which corresponds to the Distress Call that is to be relayed. Press the  key

The next page is used to specify the destination of the relay distress call and contains the selection of either ALL SHIPS, or DSC ID. The default is to "ALL SHIPS", and should be used if an official coast station's DSC ID is not known. With "ALL SHIPS" option selected, press the  key to send the distress relay.

If the DSC ID of the coast station is known, select the DSC ID option. Press the  key. Enter the DSCID in the space provided. Press the  key to send the relay.

Note that this function is not available for distress calls that have already been acknowledged.

DISTRESS LOG:

The information and status of the last 20 distress calls received or generated. This information is saved while the radio is turned off. To view the distress log, select the "DISTRESS LOG" from the main distress menu and press the  key. The distress log directory displays a list of Names or DSC ID number of the distress calls in the log. Select a name or number from the log using the  and  arrow keys. Once selected, use the  and  arrow keys to move through the rest of the distress log pages.

Distress Log page 1 displays the Name and DSC ID number of the vessel that sent the distress call. If there is no name associated with the DSC ID (not in DSC directory), then this page is not available.

Distress Log page 2 displays the Latitude and Longitude and time of position as received from the distress call.

Distress Log page 3 displays the status and other information about the distress call. If provided, the Number of People is displayed on line 2. The type of distress is displayed on Line 3 and the status of the call is on line 4. The status can be one of the following: Active, Relay, Acknowledged and Canceled.

Distress Log page 4 can only be accessed if the distress call has been acknowledged. This page displays the Name and DSC ID number of the station that acknowledged the distress call.



DISTRESS will appear in the upper line of the display and ACTIVE will appear in the lower line while waiting for an acknowledgement. If a DSC acknowledgement is not received from a shore station within two minutes, the distress call will be automatically repeated. If, after five minutes from the second call, a shore station has not acknowledged the distress call or cancelled by the sender, Distress will be re-broadcast with an updated position. Distress will continue to be re-broadcast every five minutes until either acknowledged or cancelled. When acknowledgement is received, DISTRESS CALL ACKNOWLEDGED PRESS ANY KEY will be displayed and the distress call will be automatically cancelled.

Other functions of the transceiver may be used while the emergency mode is active.

As a reminder that the Emergency mode is active, the distress tone will sound for five seconds every thirty seconds.

DUAL WATCH



Dual Watch mode allows two channels to be selected and monitored simultaneously. Any channel may be selected as the working channel and any other channel may be selected as the priority channel.



Press the   keys. The current working channel and last used priority channel numbers appear in the display.

The priority channel number appears in the smaller center digits of the display. The larger digits on the left of the display show the working channel. When activity is detected on the priority channel, the priority channel becomes the active channel. This will occur whether or not there is activity on the working channel.

The radio will transmit only on the channel number displayed in the larger digits. Pressing the Push-To-Talk button will cancel the Dual Watch mode.



To change the working channel . . .



Press the  or  key or appropriate number keys to select a working channel. A three beep tone will sound if an invalid channel is selected.



Press the   keys to change between USA and INTL frequencies.

To select or change the priority channel . . .

Press the  key. The smaller priority channel digits will begin flashing. The scan is halted while the digits are flashing.

Press the  or  key or appropriate number keys to select a priority channel.



Press the   keys to change between USA and INTL frequencies for the priority channel.



Press the  or  key to complete the priority channel selection. The transceiver will resume scanning. D/W flashing in display indicates that scanning is active.

Pressing the Push to Talk button on either channel will cancel the Dual Watch mode.

ALL CHANNEL SCAN

The All Channel Scan mode allows all channels to be sequentially scanned for activity. The scanning sequence will stop on an active channel for the duration of the activity. Three seconds after the activity stops, the scan sequence will resume.

Press the   keys. The SCAN SELECT display will appear.

Press the  or  key to select ALL CHANNELS with selection bar.

Press the  key to initiate channel scanning. All channels will be scanned in sequence.



Press the  key to override the active channel and resume scanning.



Pressing the Push to Talk button or entering a channel number will cancel the All Channel Scan mode and select the Primary mode. If the channel number is valid, the channel entered will be selected. If not valid, the channel being scanned at the first number key entry will become active.

SCAN MEMORY

Scan Memory allows the user to select any number of frequently used channels to be scanned sequentially when the Memory Scan mode is activated. Channels are selected and placed into Scan Memory while the Primary mode is active.

Press the  key to select the calling channel. The Primary mode display will appear.

Press the  or  key or appropriate number keys to select a desired channel. A three beep tone will sound if an invalid channel is selected.

Press the   keys to change between USA and INTL frequencies if necessary.



Press the  key to enter the selected channel into Scan Memory. MEM will appear in the display.



Press the  key to remove a previously selected channel from Scan Memory. MEM will not appear in display.

One or more channels may be added to, or removed from, Scan Memory any time the Primary mode is active. To scan the channels in Scan Memory, see Memory Scan.

SCAN REVIEW

Scan Review is used to review the channels stored in the Scan Memory.

Press the   keys. The SCAN SELECT display will appear.



Press the  or  key to select SCAN REVIEW with selection bar.

Press the  key to initiate Scan Review. Each channel in Scan Memory will be displayed for 1 second. Two beeps will sound at the end of the list.

MEMORY SCAN

Memory Scan mode allows the frequently used channels stored in the Scan Memory to be scanned sequentially. The scanning sequence will stop on an active channel for the duration of the activity. Three seconds after the activity stops, the scan sequence will resume.

Press the   keys. SCAN SELECT display will appear.

Press the  or  key to select MEMORY SCAN with selection bar.

Press the  key to initiate scanning. Only channels previously assigned to Scan Memory will be scanned.

Press the  key to override an active channel and resume scanning.



To permanently remove an excessively active channel from Scan Memory . . .

Press the  key while the scan is stopped on the channel.

Pressing the Push to Talk button or entering a channel number will cancel the Memory Scan mode and select the Primary mode. If the channel number is valid, the channel entered will be selected. If not valid, the channel being scanned at the first number key entry will become active.



HAIL

Hail mode allows the transceiver's microphone to be used as a power hailer when an optional external speaker is installed. The Hail mode has a listen-back feature that provides two way communication through the hail speaker.

Press the   keys to select the Hail mode. The HAIL display will appear.



Press the microphone button to speak through the hail speaker. TALK will appear in the display.

Release the microphone button to listen through the hail speaker. LISTEN will appear in the display. Use the VOL knob to adjust the talk and listen levels.

Press the   keys again or enter a valid channel number to exit the Hail mode and resume Primary mode operation.



INTERCOM

The Intercom mode provides two way aural communication from the transceiver to an optional remote intercom speaker.

Press the   keys to select the Intercom mode. The INTERCOM display will appear.

Press the microphone button to speak through the intercom speaker. TALK will appear in the display.

Release the microphone button to listen through the intercom speaker. LISTEN will appear in the display. Use the VOL knob to adjust the talk and listen levels.

Press   keys again or enter a valid channel number to exit the Intercom mode and resume Primary mode operation.

USER SETUPS

User Setups allow certain characteristics of the DSC 500 to be set or changed according to the user's preference. Once the preferences have been set, they will be retained in memory until again changed by the user.

The general method for changing User Setups is shown below. Specific procedures for each selection follow.



General Procedure

Press the **SET** key. The USER SETUPS menu will appear.



The User Setup selections are: CLOCK, VIEWING ANGLE, USER DSC ID, USER OPTIONS, NMEA POSITION and SECURITY CODE. Each selection has optional settings other than the factory settings.



CAUTION

If a security code is entered and not remembered, the transceiver's advanced features will not function. Contact your dealer or the **ROSS Engineering Co.** to restore the unit to full operation.

Press the  or  key to position the selection bar on the desired selection.

Press the **ENT** key to complete the selection. The appropriate setup page will appear.

Press the  or  key to select the character to be changed.

Press the  or  or a number key to change a value.

Press the **ENT** key to complete the operation and return to the User Setups menu.

NOTE





If the **ENT** key is not pressed to complete an operation, the new setup information will not be remembered.

Clock

The CLOCK setup page allows the user to choose how the time of day will appear in certain displays. The time may be displayed as either local time or UTC time. Local time may be displayed in AM/PM or 24 hour format. UTC time is always displayed in 24-hour format.



Press the  key. The USER SETUPS menu will appear.

Press the  key. The Clock display will appear. The date and day of the week appear in the lower line of the display. The large digits display the hour and the minute. Seconds are displayed to the lower right. The two letters in the upper right hand corner of the display indicate how the time is displayed. AM or PM indicates 12 hour format, MT indicates 24 hour military format and UT indicates Universal Coordinated Time. Universal Coordinated Time has been known as Greenwich Mean Time (GMT) or Zulu time.

Press either the   or   keys to change between AM/PM or MT or UT.

To change the time, date, day of week or local time offset from UTC . . .

Press the  key. The INITIALIZE page will appear. The UTC time, date and day of week appear in the lower two lines of the display. The LOCAL SET line in the display show the offset from UTC to local time as + or - the number of hours from your location to the Greenwich meridian. The + or - sign will be flashing.

Press the  key to change the sign. Then press the  key to select the next digit in the offset field. Enter the correct number of hours. As each digit is entered, the flashing digit will move to the next position.

If this is the first time you have set the clock, you may want to set the time several minutes ahead to allow for following the instructions.

To correct an entry . . .

Press the  key to backspace.

To skip a digit . . .

Press the  key.

Enter the correct UTC time in hours and minutes. As each digit is entered, the flashing digit will move to the next position.

After the time is set, the flashing digit will move to the first digit on the lower line of the display.

Press the appropriate number keys to enter the date.

When the date is complete . . .

Press the  key repeatedly to select the day of the week.

When all information is displayed correctly . . .

Press the  key. The clock will be started at 00 seconds and the Clock display will appear.

If desired, the clock may be set accurately to the second by setting the time a minute ahead and then pressing the  key at 00 seconds on the time reference.

If a GPS navigation receiver is connected to your DSC 500, the time will be corrected according to the very accurate UTC time available from the GPS system.

Viewing Angle



The Viewing Angle function allows the display to be adjusted for the best contrast over a range of viewing positions and lighting conditions.

Press the  key. The USER SETUPS menu will appear.

Press the  or  key to select VIEWING ANGLE with the selection bar.

Press the  key. The INITIALIZE VIEWING ANGLE page will appear. A number, 0~7, will appear flashing in the lower line of the display.

Observe the display from the intended viewing position.

Press the  or  key or an appropriate number key (0~7) to change the contrast between the background and the displayed characters. Higher numbers tend to darken the background while lower numbers lighten the background. The factory setting is 4.

Press the  key to complete the operation and return to the User Setups menu.

User DSC ID

Your FCC issued Ship Station Identity number, 9 digits, must be entered into the DSC 500 in order to send or receive DSC calls. This is not your voice call sign or vessel registration number. A Ship Station Identity number may be requested by checking box 20 (YES) on FCC form 506A, Application for Ship Radio Station License.

To protect against the unauthorized use of ID numbers, a Ship Station Identity number may be entered or changed only ONE time. Any further attempts to change the number will cause USER DSC ID CAN NO LONGER BE CHANGED to appear in the display and the last ID number entered will become permanent. The transceiver must be returned to the factory or authorized dealer to clear this condition.

To enter your Ship Station Identity number . . .

Press the  key. The USER SETUPS menu will appear.

Press the  or  key to select USER DSC ID with the selection bar.

Press the  key. The DSC ID, NAME/NUMBER page will appear. The lower two lines of the display will show dashes unless a name and number have been previously entered. A name must be entered on the second line from the bottom of the display and the ID number must be entered on the lower line. A name may be one or more alphanumeric characters but the ID number must be nine digits.

Names are entered by pressing the number key that is associated with the letters of the alphabet printed above them. The number for that key may be used as part of the name also. Alphabetic entries are allowed only on certain pages for entering names into directories. At all other times, pressing a number key will enter a numeric value only.

To enter a letter into the name line of the display, press the appropriate number key. Press the key repeatedly until the desired letter or the number appears in the character position. Then, press the next key. The entry point will move to the next position automatically. If more than one letter from the same key must be entered in succession . . .

Press the  key to move the entry point to the next character position.



To correct an entry . . .

Press the  key to backspace.

When the name is complete . . .

Press the  key to move the entry point to the ID number line.

Press the appropriate number keys to enter your Ship Station Identification number.

To correct an entry, press the  key to backspace. To skip a digit, press the  key. When all information is displayed correctly . . .

Press the  key to complete the operation and return to the User Setups menu.

User Options

The User Options page allows certain operational options to be selected. There are seven functions, each having two or more options, that may be set by the user.

Press the **SET** key. The USER SETUPS menu will appear.

Press the **▲** or **▼** key to select USER OPTIONS with the selection bar.



Press the **ENT** key. The USER OPTIONS page will appear with a seven digit number in the second line of the display. The currently selected options are represented by the value appearing in each digit of the number. The flashing digit indicates the active digit position and the lower two lines of the display show the function and the option for that position.

Each digit position in the number represents a function. The value in each digit position represents the option selected.

The table below shows the seven functions and the options for each function. An explanation of each function follows the table.

	0	1	2	3	4	5	6	7
DSC BUSY TIME-								-LAT/LON RESOLUTION
BUSY 30 SEC 0								0 DECIMALS
BUSY 60 SEC 1								1 DECIMALS
BUSY 15 SEC 2								2 DECIMALS
NEVER BUSY 3								3 DECIMALS
ALWAYS BUSY 4								4 DECIMALS
								-NMEA INTERFACE DATA
RING VOLUME-								OUTPUT FORMAT
								0 \$LCGLL
LOUD 0								1 \$CDWPL & \$CDBWC
SOFT 1								2 \$CDGLL, \$CDWPL, \$CDBWC
								3 PROPRIETARY
								4 \$GPGGA, \$XXVTG, \$GPGSV
BEEP OPTIONS-								-POSITION TYPE
ALL ON 0								
CALLS ONLY 1								0 LAT/LON
ALL OFF 2								1 TD PAIR
								-POSITION XMIT
								0 XMIT ENABLE
								1 XMIT DISABLE
								-AUTO POLLING INTERVAL WITH SPECIAL SOFTWARE
								2 5 MINUTES
								3 2 MINUTES
								4 30 SECONDS
								5 15 SECONDS

Press the  or  key to select a digit position. The active digit position will flash.

Press the  or  key repeatedly to change to the desired value. When all digit positions are set to the desired option . . .

Press the  key to complete the operation and return to the User Setups menu.

DSC BUSY TIME: The amount of time, after the release of the Push to Talk button, that the transceiver will respond to a DSC call with a busy signal. This function prevents interruption, from DSC calls, during pauses in on-going communication.

BEEP OPTIONS: Allows the beeper to be turned Off. If ALL ON is selected, the beeper will sound on every keystroke and on DSC calls both sent and received. CALLS ONLY will sound the beeper only at power On or when a DSC call is received. ALL OFF will silence the beeper. The distress signal will still sound with any option.

POSITION XMIT: Determines the transceiver's response to a request for position from another DSC radio. If enabled and an operating navigation receiver is connected, your vessel's position will be transmitted upon request. If disabled or a navigation receiver is not connected, No Position Available will be transmitted. If a distress signal is sent, position coordinates will be transmitted with either option selected, providing a navigation receiver is properly connected and operating.

RING VOLUME: Sets the volume of the DSC ring tones and the distress Hi/Lo sound of the DSC 500. The beeps sounded as key responses are fixed at low volume.

POSITION TYPE: Determines whether Latitude/Longitude or Loran TD position coordinates are transmitted with the Send Position function or in response to a request for position (if Position Xmit is enabled). Also determines the type of coordinates output through the data interface. If a distress signal is sent Lat/Lon coordinates are transmitted with either option selected, providing a navigation receiver is properly connected and operating.

NOTE

Transmitting and receiving TD position coordinates is a proprietary feature of the DSC 500. Other manufacturers are not required to support this feature and may not accept TD positions.

INTERFACE: Allows for selection of NMEA output sentences available from the data interface. Each selection provides one or more sentences to facilitate connection to plotters, displays or personal computers.

Option 0: Outputs the \$LCGLL sentence for any Lat/Lon position received from another vessel.

Option 1: Outputs \$CDWPL and \$CDBWC sentences for Lat/Lon positions received from another vessel.

Option 2: Repeats every 5 seconds a \$CDGLL sentence for any Lat/Lon position received through the NMEA data input to the DSC 500. Also outputs \$CDWPL and \$CDBWC sentences each time a Lat/Lon position is received from another vessel.

Option 3: Proprietary

Option 4: Repeats character for character \$GPGGA, \$xxVTG and \$GPGSV sentences received through the NMEA data input.

NMEA Position

The NMEA Position function displays the position coordinates from a navigation receiver connected to the data interface.

Press the **SET** key. The USER SETUPS menu will appear.

Press the  or  key to select NMEA POSITION with the selection bar.

Press the **ENT** key. The NMEA POSITION page will appear. If position information is available from a navigation receiver, The coordinates will appear. If a receiver is not connected or not operating, NO POSITION AVAILABLE will appear in the lower two lines of the display.

The DSC protocol specifies Lat/Lon coordinates for position reporting. The DSC 500 is capable of using both TD and Lat/Lon coordinates, depending upon the POSITION TYPE setting on the User Options page, if available from a navigation receiver. Most Loran receivers will navigate in either TD or Lat/Lon mode but some Loran receivers do not send Lat/Lon position coordinates to their data interface when navigating in TD mode. Consequently, if the DSC 500 is set for Lat/Lon coordinates and only TD data is available, NO POSITION AVAILABLE will appear in the display. It should also be noted that other manufacturers of DSC transceivers are not required to support this feature and may not accept TD positions.

Security Code

The Security Code feature is provided to prevent unauthorized use of the DSC 500. Once a security code has been entered, the same code must be entered each time the transceiver is turned On. The code may be changed or deleted at any time by an authorized user. If three attempts are made to enter an incorrect code, the transceiver will operate in a limited manner to provide minimal effective use in an emergency. Under these circumstances, only the Primary mode, Emergency mode and the Weather mode will operate. Attempts to select other modes will sound the three beep error tone.

CAUTION

If a security code is entered and not remembered, the transceiver's advanced features will not function. Contact your dealer or **ROSS Engineering Co.** to restore the unit to full operation.

Press the **SET** key. The USER SETUPS menu will appear.



Press the  or  key to select SECURITY CODE with the selection bar.

Press the **ENT** key. The SECURITY CODE page will appear. Four dashes appear on the second line of the display if no code has been entered. The software version number, VER: #~#, appears in the lower line of the display. If a four digit code number appears in the second line, it may be changed or deleted or left as is.

To clear an existing number . . .

Press the **CLR** key twice. Four dashes will appear in the display.

To change an existing code or enter a new one, press the desired number keys. Four digits without spaces must be entered.

To correct an entry, press the  key to backspace. To skip a digit, press the  key. When all information is displayed correctly . . .

Record the code number in a safe place. The next time the transceiver is turned On, you must know the code.

Press the **ENT** key to complete the operation and return to the User Setups menu.

Number People

This option is used to declare the number of people on the vessel and is attached to the distress call information that is sent when a distress call is activated. Select the option "NUMBER PEOPLE" from the User Setups menu and press the **ENT** key.

Enter the number of people using the digit keys on the keypad, press **ENT** to save the information. This option is saved when the unit turned off as with all User Setup options.

DIGITAL SELECTIVE CALL FUNCTIONS

The DSC 500 offers many Digital Selective Calling features to improve communication effectiveness and reduce channel congestion. The Digital Selective Call functions of the DSC 500 are divided into four different operating modes: the DSC mode is for placing individual and group calls, the ANSWER mode is for returning received calls. The TELEPHONE mode is for placing phone calls and the SCRAMBLER mode is used to keep conversation private. Each mode is tailored for its particular type of DSC communication. Also, each mode has one or more directories and other supporting functions to enhance the DSC communication capability.

All DSC calls are automatically sent and received on channel 70. Channel 70 has been designated specifically for DSC service and must not be used for voice communication. The DSC calling procedure requires the selection of a working channel prior to making a call. After DSC contact is established on channel 70, the transceiver automatically switches to the selected working channel for routine communication.

In order to use the DSC mode to send and receive calls, two things must be done.

1. Your Ship Station Identity number must be entered into the User DSC ID page of the User Setups mode. Please see USER SETUPS for the procedure.
2. The name and Ship Station Identity number of at least one other DSC equipped vessel must be entered into the DSC Calling directory. Please see DIRECTORIES for the procedure.

DSC Mode Menu Arrangement

Most of the DSC functions of the DSC 500 are accessed through the DSC mode. The SCRAMBLER, TELEPHONE and ANSWER modes are all DSC functions as well but since they are more specific in their purpose they are treated as individual modes.

The general arrangement of the menus and data pages is the same for all DSC modes. Since the basic DSC mode has the most functions, it will be described here.

DSC functions are selected from menus. Some menus have additional data pages. We will come back to the data pages later, for now let's concentrate on menus. When the DSC mode is selected from the keypad, the first menu to appear is the DSC CALLING menu. There are seven other menus to support additional features of the DSC mode. They are: DSC STANDBY, ALL SHIPS, DISTRESS DATA, GROUP POSITION, GROUP CALLING, REQUEST POSITION and SEND POSITION. Each of the menus may be reviewed by selecting the DSC mode and pressing the left arrow key. Each time the left arrow key is pressed, a different menu will appear in the display. The menu sequence will repeat continuously.

Some menus have additional data pages or directories. If a menu has data pages, an arrow symbol will appear on the right hand edge of the display. To turn to the next page, press the right arrow key. If the right arrow key is pressed repeatedly, the next menu page will appear, then its data pages and then the next menu etc..

Pressing the left arrow key scrolls through the DSC functions menu and pressing the right arrow key scrolls through the menus and their data pages.

If a menu has a directory, a reverse video bar will appear in the lower line of the display. The bar may be positioned with the up and down arrow keys to highlight the desired selection. When certain selections are activated another page will appear which either presents more information or allows the user to enter information into the page. On other selections, the highlighted data will be used when the DSC function is executed. On menus that do not offer choices, the selection bar appears in the upper line of the display and cannot be moved.

DIRECTORIES

The Directory is the data base for placing and answering DSC calls. Both vessel names and Ship Station Identity numbers are entered into the directories. Although only the Ship Station Identity numbers are used to place and answer calls, having the corresponding names make selection and identification much easier.

There are five directories used for either sending or receiving DSC calls. They are: DSC Calling for calls to other vessels and to private coast stations, Group Calling for ship to ship group calls, Telephone and Coast Station directories for placing unattended calls to residence or business telephones and Call Waiting for logging and returning received DSC calls. Another directory, Distress Data, logs vessel ID, time and position of vessels sending DSC distress calls.

The contents of all directories are protected from loss by an internal memory battery.

The basic procedure for entering names and numbers into directories is the same for all directories except Call Waiting and Distress Data. These two directories automatically log received DSC calls and do not accept user entries from the keypad. However, logged entries may be cleared as desired from the Call Waiting directory.



Each directory is described below. Please see BUILDING DIRECTORIES for procedures for entering, editing and clearing information in directories.

DSC Calling Directory

The DSC Calling directory's purpose is to store the user's list of vessels or coast stations and their ID number for use in placing DSC calls. When a DSC call is made, the vessel's name or ID number is first selected from the directory.

The DSC Calling directory will accept 200 entries of vessel names and their Ship Station Identity numbers. The name may be one to ten characters. Letters, numbers and spaces may be used in the name but a least one character must be entered. An ID number without a name will not be accepted. The ID number must be all nine digits of the Ship Station Identity number issued by the FCC with the Ship Radio Station License.

To access the DSC Calling directory . . .

Press the   keys. The DSC CALLING menu will appear in the display.



DSC Group Calling Directory

The DSC Group Calling directory allows vessels with common interests to be listed in a separate directory and be identified with a common group ID number. When a group call is made, all vessels belonging to that group will receive the call.

Group ID numbers start with a zero (0). Presently, the procedure for obtaining Group call ID numbers is not clear. Please contact the FCC for the latest information.

The DSC Group Calling directory will accept 50 entries of group names and their Group ID numbers. Group names should uniquely differ from individual names in the DSC Calling directory to avoid confusion when calls are received. The name may be one to ten characters and the ID number must be nine digits. Letters, numbers and spaces may be used in the name but a least one character must be entered. An ID number without a name will not be accepted.

To access the DSC Group Calling directory . . .

Press the   keys. The DSC CALLING menu will appear in the display.

Press the  key repeatedly until the GROUP CALLING menu is displayed.

DSC Coast Station Directory

The DSC Coast Station directory is used to store the names and DSC ID numbers of public coast stations equipped to provide telephone service for ship to shore communication. The DSC Coast Station directory is combined with the DSC Telephone directory. When a DSC ship to shore telephone call is placed, the coast station is selected first, then the telephone number is selected.

The DSC Coast Station directory will accept 50 entries of station names and their ID numbers. The name may be one to ten characters and the ID number must be nine digits. Letters, numbers and spaces may be used in the name but a least one character must be entered. An ID number without a name will not be accepted.

To access the DSC Coast Station directory . . .

Press the   keys. The TELEPHONE menu will appear in the display.



Press the  key. The COAST STATION menu will appear in the display.

DSC Telephone Directory

The DSC Telephone directory is used to store names and telephone numbers of individuals or business for direct contact through DSC equipped coast stations. The Telephone directory includes the DSC Coast Station directory. When a DSC ship to shore telephone call is placed, the coast station is selected first, then the telephone number is selected.

The DSC Telephone directory will accept 200 entries of individual names and their telephone numbers. The telephone number may be up to 16 digits long, while the name may not exceed 10 characters. Letters, numbers and spaces may be used in the name but a least one character must be entered. A telephone number without a name will not be accepted. Letters are not accepted in telephone numbers.

To access the DSC Telephone directory . . .

Press the   keys. The TELEPHONE menu will appear in the display.

DSC Call Waiting Directory

The DSC Call Waiting directory logs all DSC calls that are received and not answered within 60 second. Calls will be logged while busy with other communication as long as the transmitter is not keyed at the time of the call. If the call is answered within 60 seconds the call will not be logged. When a call is logged, a message will appear in the Primary mode display.

The DSC Call Waiting directory will accept 100 received DSC calls. When a DSC call is received, the caller's ID number is logged into the Call Waiting directory with the time of day. If the caller's ID number also resides in your DSC Calling directory, the name will be logged also. NO NAME will appear otherwise.

Calls may be returned to any logged entry and any entry may be cleared from the directory but no user entries are accepted into the Call Waiting directory. A special feature of the Call Waiting directory allows NO NAME calls to be transferred into the DSC Calling directory. Please see Transfer or Clear from Call Waiting in the BUILDING DIRECTORIES section.

To access the DSC Call Waiting directory . . .

Press the   keys. The CALL WAITING menu will appear in the display.

BUILDING DIRECTORIES

The DSC Calling directory, the Group Calling directory, the Telephone and Coast Station directories all require the user to enter specific information in order for the DSC 500 to send DSC calls to other DSC equipped vessels or shore stations. The basic procedure for entering the information is the same for all of the directories. The information stored in the directories may be changed or deleted as desired. Entries are automatically arranged in alphabetical order according to name. A copy of the last completed entry will also appear at the top of the list.

New Directory Entry

To access a directory, first select the appropriate mode.

To access the Telephone and Coast Station directories, enter the Telephone mode . . .



Press the   keys.

To access the DSC Calling or Group Calling directories, enter the DSC mode . . .

Press the   keys.

When the desired mode is active . . .

Press the  key as necessary to select the desired directory.

Press the  or  key to position the selection bar on NEW ENTRY.

Press the  key. The ENTER NEW, NAME/NUMBER page will appear. Dashes will appear in the lower two lines of the display.

A name must be entered on the second line from the bottom of the display and the ID number must be entered on the lower line. A name may be one or more alphanumeric characters but the ID number must be nine digits.

Names are entered by pressing the number key that is associated with the letters of the alphabet printed above them. The number for that key may be used as part of the name also. Alphabetic entries are allowed only on certain pages for entering names into directories. At all other times, pressing a number key will enter a numeric value only.

To enter a letter into the name line of the display, press the appropriate number key. Press the key repeatedly until the desired letter or the number appears in the character position. Then press the next key. The entry point will move to the next position automatically. If more than one letter from the same key must be entered in succession . . .

Press the  key to move the entry point to the next character position.

To enter a space . . .

Press the  key twice.



To correct an entry . . .

Press the  key to backspace.

When the name is complete . . .

Press the  key to move the entry point to the ID number line.

Press the appropriate number keys to enter the Ship Station Identification number.



To correct an entry, press the  key to backspace. To skip a digit press the  key. When all information is displayed correctly . . .

Press the  key to complete the operation. The DSC Calling menu will appear and the newest entry name will appear with the selection bar in the lower line of the display.

To check the ID number for the name . . .

Press the  key. The corresponding ID number will appear with the selection bar in the lower line of the display.

To return to the name, press the  key.

Notice that each directory has a names page and a numbers page. To switch back and forth, use the arrow keys as shown above. Also, other names and numbers in the directory may be recalled by pressing the  or  key. The directory list will scroll when an arrow key is held depressed.

To add more entries to the directory, select NEW ENTRY from the menu and repeat the above entry procedure.

To exit the directory and return to the Primary mode . . .

Press the appropriate function keys again or enter a valid channel number.

To exit the directory and select another mode . . .

Press the function keys for the desired mode.

Change or Remove an Existing Entry

To access a directory, first select the appropriate mode.

To access the Telephone and Coast Station directories, enter the Telephone mode . . .



Press the   keys.

To access the DSC Calling or Group Calling directories, enter the DSC mode . . .

Press the   keys.

When the desired mode is active . . .

Press the  key as necessary to select the desired directory.

Press the  or  key to position the selection bar on the entry you want to change or remove.





Press the  key. The ENTER NEW page will appear with the selected entry information displayed. The first character in the name will be flashing.

To remove the selection from the directory . . .

Press the  key twice. Dashes will appear in the name line of the display.

Press the  key. Both the name and ID number have been cleared from the directory.

To change the name or ID number for the selection . . .

Press the   or   keys to move the flashing entry point to the character to be changed.

Press the appropriate number keys to make the desired changes.



When all information is displayed correctly . . .



Press the  key to complete the operation and enter the changes into the directory.

Transfer or Clear from Call Waiting Directory

A special feature of the Call Waiting directory allows NO NAME entries to be transferred directly into the DSC Calling directory. Named entries appearing in the Call Waiting directory already have their ID numbers listed in the DSC Calling directory. The transfer is accomplished by giving the ID number a name. This feature eliminates the inconvenience of obtaining, recording and manually entering the information. Also keep in mind, calls are not logged into the Call Waiting directory unless unanswered for 60 seconds.

To access the DSC Call Waiting directory . . .

Press the   keys. The CALL WAITING menu will appear in the display.

Press the  or  key to position the selection bar on the entry you want to transfer or clear.

If the selection has a name and you want to remove it from the directory . . .

Press and hold the  key for 2 seconds. The selection will be cleared and the next entry in the directory will appear with the selection bar.

If the selection is NO NAME . . .

Press and hold the  key for 2 seconds. The ENTER NEW, NAME/NUMBER page will appear. The ID number will appear in the lower line of the display and dashes will appear in the line above the ID number. The first dash will be flashing.

To Clear the Entry

Press the  key. The entry is cleared. ID numbers are not accepted without names.

To Transfer the Entry

A name must be entered in order to transfer the selected entry. A name may be one or more letters or numbers and may include spaces. At least one character must be entered.

Names are entered by pressing the number key that is associated with the letters of the alphabet printed above them. The number for that key may be used as part of the name also.

Press the appropriate number keys to enter a name.

When all information is displayed correctly . . .

Press the  key. The CALL WAITING display will appear and the new name will appear at the top of the list with the selection bar. The new name and its corresponding ID number have been added to the DSC Calling directory also.

Searching Directories

The Search function allows names in long directory lists to be located quickly. The Search function searches for names, not ID numbers, although numbers may be included in names.

To use the Search function, one or more characters of a name are entered. The directory list is searched alphabetically for the first search character. The search will stop on the first occurrence of the search character. If a name starting with the first character is found and more than one search character was entered, the search will continue to look for the next character etc. until no further matches are found. If no occurrences of the first search character are found, then the search will stop at the last name in the list whose first character's alphabetical rank is lower than the first search character. There is no attempt made to find a name using the second search character if no name using the first character is found.

To search a directory, first select the appropriate mode.

To access the Telephone and Coast Station directories, enter the Telephone mode . . .



Press the   keys.

To access the DSC Calling and Group Calling directories,
enter the DSC mode . . .

Press the   keys.

When the desired mode is active . . .

Press the  key as necessary to select the desired directory.



Press the  or  key to position the selection bar on SEARCH in the directory menu.

Press the  key. ENTER UP TO TEN CHARACTERS will appear in the display. Ten dashes will also appear on the lower line of the display. The first character position will be flashing.

Press the appropriate keys to enter one or more characters of the name to be found.

Letters are entered by pressing the number key that is associated with the letters of the alphabet printed above them. The number for that key may be used as part of the name also.

Press the  key to complete the operation. The name alphabetically nearest to the search character(s) will appear in the display with the selection bar.

Press the  or  keys to position the selection on another entry if necessary.

Once the desired entry is found, any appropriate function may be activated using the entry.

DSC CALLING

The Digital Selective Call functions of the DSC 500 are divided into four different operating modes: the DSC mode is for placing individual and group calls and the ANSWER mode is for returning received calls. The TELEphone mode is for placing phone calls and the SCRAMbler mode is used to keep conversation private. Each mode is tailored for its particular type of DSC communication.

All DSC calls are automatically sent and received on channel 70. Channel 70 has been designated specifically for DSC service and must not be used for voice communication. The DSC calling procedure requires the selection of a working channel prior to making a call. After DSC contact is established on channel 70, the transceiver automatically switches to the selected working channel for routine communication.

To Place a DSC Individual Call

- Select the Primary mode by exiting any other active function.

Press the appropriate number keys to select the desired working channel. A three beep tone will sound if an invalid channel number is entered.

Press the   keys. The DSC CALLING menu will appear in the display.

Press the  or  key to select the desired party from the directory.

Press the  key to initiate the call. The called party's name and WAITING will appear in the display. A three or four beep tone will sound and a status message will appear in the display. Proceed with an appropriate response to the message.

Status messages are . . .

ANSWERED. Contact with the called vessel was established. After several seconds, the transceiver will switch to the Primary mode and the selected working channel will be active. Normal communication may begin immediately. The called party's name will appear in the lower line of the display. The time of day will return to the lower line of the display after 1 minute.

NO RESPONSE. Contact with the other vessel could not be established. After several seconds, the DSC Calling directory will reappear with the called party's name at the top of the list. You may call again later or select another party to call.

BUSY. Contact was established but the called transceiver was busy. Your call will be logged into the other transceiver's Call Waiting directory. After several seconds, the DSC Calling directory will reappear with the called party's name at the top of the list. You may call again later or select another party to call.

UNATTENDED. Contact was established with the other vessel. The other vessel's transceiver is set to reply with the unattended message. For some reason an operator is not available to respond. Your call will be logged into the other transceiver's Call Waiting directory. After several seconds, your DSC Calling directory will reappear with the called party's name at the top of the list. You may call again later or select another party to call.

Please see User Options in the USER SETUPS section for Busy conditions and DSC Standby later in this section for the Unattended condition.



To Place a DSC Group Call

Select the Primary mode by exiting any other active function.

Press the appropriate number keys to select the desired working channel. A three beep tone will sound if an invalid channel number is entered.

Press the   keys. The DSC CALLING menu will appear in the display.

Press the  key repeatedly until the GROUP CALLING menu appears.

Press the  or  key to select the desired group name from the directory.

Press the  key to initiate the call. The called group's name and WAITING will appear in the display.

In group calls, there is no acknowledgement from the called vessels. After several seconds, the transceiver switches to the Primary mode and the selected working channel is active. The group name will appear in the lower line of the display. Normal communication may begin immediately and a voice poll or role call should be made to confirm which group members are present. The time of day will return to the lower line of the display after 1 minute.

DSC ANSWERING & CALL WAITING

Your DSC 500 will receive DSC calls while idle, that is monitoring any channel, or while busy in routine communications or otherwise unavailable. When idle and monitoring a channel, DSC calls may be answered immediately. If busy or unavailable, DSC calls are logged into the Call Waiting directory and may be answered when convenient. Group calls are logged as the individual initiating the group call. The group ID is not logged.

The answering procedure follows for each situation.

Call received while Idle

Short Hi/Lo beeps signal a DSC call. RECEIVED DSC CALL FROM with the caller's name or DSC call sign will appear in the display for 5 seconds. Then the Primary mode display will appear with the caller's name or DSC call sign in the lower line. The channel number displayed will be the caller's working channel.

The sound will repeat every 8 seconds until the call is answered or until the call is logged into the Call Waiting directory after 60 seconds.

To answer the call . . .

Press the Push to Talk on the microphone button and acknowledge the call verbally. If the call is not answered within 60 seconds, it will be logged into the Call Waiting directory and may be answered as described below.

To silence the beeps without answering the call . . .

Press the **CLR** key. The call will not be logged.

Call received while Busy or Unattended



Short Hi/Lo beeps will sound once to signal a DSC call. The call will be logged into the Call Waiting directory. The vessel that called will appear flashing in the lower line of the Primary mode display.

When you are able to return the call . . .

Press the appropriate number keys to select the desired working channel. A three beep tone will sound if an invalid channel number is entered.

Press the   keys. The CALL WAITING menu will appear in the display.

The selection bar will be on the last call received.

Press the  or  key to select the desired caller from the directory.

Press the  key to answer the call on the current working channel of your radio.

The called party's name and WAITING will appear in the display. A three or four beep tone will sound and a status message will appear in the display. Proceed with an appropriate response to the message.

Status messages are . . .

ANSWERED. Contact with the called vessel was established. After several seconds, the transceiver will switch to the Primary mode and the selected working channel will be active. Normal communication may begin immediately. The called party's name will appear in the lower line of the display. The time of day will return to the lower line of the display after 1 minute.

NO RESPONSE. Contact with the other vessel could not be established. After several seconds, the DSC Calling directory will reappear with the called party's name at the top of the list. You may call again later or select another party to call.

BUSY. Contact was established but the called transceiver was busy. Your call will be logged into the other transceiver's Call Waiting directory. After several seconds, the DSC Calling directory will reappear with the called party's name at the top of the list. You may call again later or select another party to call.



UNATTENDED. Contact was established with the other vessel. The other vessel's transceiver is set to reply with the unattended message. For some reason an operator is not available to respond. Your call will be logged into the other transceiver's Call Waiting directory. After several seconds, your DSC Calling directory will reappear with the called party's name at the top of the list. You may call again later or select another party to call.

Please see User Options in the USER SETUPS section for Busy conditions and DSC Standby later in this section for the Unattended condition.

Geographic Area Calling

The DSC 500 will respond to and generate a Geographic Area type DSC call. This type of DSC can be used to contact a vessel by its location without the need to know its DSC ID. A geographic area is a rectangle that is constructed by a reference point (latitude, longitude) and 2 sides defining the number of degrees and minutes for the North-to-South sides and the West-to-East side.

This function is located in the DSC Directory, and can be accessed by going into the DSC Directory and page left () until the title "GEOGRAPHIC AREA CALLING ALL SHIPS" is displayed.

To make a geographic area call, press the  key to open the edit. Enter the latitude of the reference point on line one and the longitude reference point on line two. Enter the number of degrees and minutes of the North-to-South side on line three and the West-to-East side on line four. Press the  key to activate the DSC call after all four information fields have been defined. The geographic area call will switch all vessels within the defined area to the calling radio's working channel just like a DSC Group Call (see the previous sections for information on the DSC Group Call).

SCRAMBLER

The Scrambler mode allows conversation on any working channel to be kept private. Conversation between two, or more if desired, DSC 500s will be loud and clear while others who may be monitoring the channel will hear only garble. Scrambler mode uses the same DSC Calling directories as unscrambled DSC calls. Both individual and group calls can be scrambled.



The Scrambler does not make a channel private. The channel must still be shared with other traffic. A unique feature of the Scrambler allows the working channel to be changed by either party and the other party's transceiver will change channels automatically to stay in contact. This feature works with group scrambled calls too. If anyone in the group changes channels, all others in the group will automatically switch to the new channel.

To Place a Scrambled Individual Call

Select the Primary mode by exiting any other active function.

Press the appropriate number keys to select the desired working channel. A three beep tone will sound if an invalid channel is selected.

Press the   keys. The SCRAMBLER INDIVIDUAL menu will appear in the display.

Press the  or  key to select the desired party from the directory.

Press  key to initiate the call. SCRAMBLER will appear in the upper line of the display and INITIALIZING will appear in the lower line. Working channel information will also be displayed.

A three or four beep tone will sound and either the called party's name or a status message will appear in the display.

If the called party's name appears, the call was completed and scrambled voice communication may proceed.

If a status message appears in the display, proceed with an appropriate response to the message.

Status messages are . . .

NO RESPONSE. Contact with the other vessel could not be established. After several seconds, the Scrambler Individual directory will reappear with the called

party's name at the top of the list. You may call again later or select another party to call.

BUSY. Contact was established but the called transceiver was busy. Your call will be logged into the other transceiver's Call Waiting directory. After several seconds, the Scrambler Individual directory will reappear with the called party's name at the top of the list. You may call again later or select another party to call.

UNATTENDED. Contact was established with the other vessel. The other vessel's transceiver is set to reply with the unattended message. For some reason an operator is not available to respond. Your call will be logged into the other transceiver's Call Waiting directory. After several seconds, your Scrambler Individual directory will reappear with the called party's name at the top of the list. You may call again later or select another party to call.

To Place a Scrambled Group Call



Select the Primary mode by exiting any other active function.

Press the appropriate number keys to select the desired working channel. A three beep tone will sound if an invalid channel is selected.

Press the   keys. The SCRAMBLER INDIVIDUAL menu will appear in the display.

To place a scrambled Group Call . . .



Press the  key. The SCRAMBLER GROUP menu will appear in the display.

Press the  or  key to select the desired party from the directory.

Press  key to initiate the call. SCRAMBLER will appear in the upper line of the display and INITIALIZING will appear in the lower line. Working channel information will also be displayed.

When the group name appears in the lower line of the display, voice contact may be initiated. In group calls there is no acknowledgement from the called vessels. A voice poll or role call should be made to confirm which group members are present.

To Change Scrambler Channels

Press the  or  key or press the appropriate number keys to select a different working channel. A three beep tone will sound if an invalid channel is selected.

NEW CHANNEL will appear in the lower line of the display.

Press  key to complete the operation. INITIALIZING will appear in the lower line of the display.

When the called party's name returns to the lower line of the display, the channel change is complete and scrambled voice contact may resume.

If the Push to Talk button is pressed before pressing the  key, the Scrambler mode will be cancelled and the Primary mode will become active.

To Cancel Scramble Mode

Press the   keys again or . . .



Change channels and press the Push to Talk button instead of the  key or . . .

Press the appropriate function keys to activate another mode.

To Resume Scramble Mode

The Resume feature allows the user to interrupt scrambled conversation to use the transceiver for other communication and return to the scrambled conversation without having to re-initialize. The working channel and scramble codes are remembered by the transceiver. The Resume feature may be used in both individual and group scramble communication.

To resume a scrambled call . . .

Press the   keys. The Scramble menu will appear.

Press the  key to select RESUME.

Press the  key. The SCRAMBLER display will appear showing the working channel and other vessel's name.

DSC STANDBY

The DSC Standby function allows the transceiver to reply to DSC calls with the Unattended message and log the calls for return at a more convenient time. When set to the DSC Standby mode, voice traffic may still be monitored on any selected channel.

Press the appropriate number keys to select the desired channel to monitor. A three beep tone will sound if an invalid channel is selected.

Press the   keys. The DSC CALLING menu will appear in the display.

Press  key once. DSC STANDBY, CHANNEL number, RADIO IS UNATTENDED will appear in the display with the selected monitor channel number.

Now, when a DSC call is received, the radio will respond with the unattended message informing the caller that an operator is not available to answer the call. Calls received will be logged into the Call Waiting directory.

Entering a valid channel number or pressing the Push to Talk button will cancel the DSC Standby mode and switch to the Primary mode.

ALL SHIPS CALL

The All Ships Call function allows contact to be established with other DSC equipped vessels without having their Mobile Service Identity number in the calling ships directory. Also, priority for the call is designated as Urgency, Safety or Routine.



Select the Primary mode by exiting any other active function.

Press the appropriate number keys to select the desired working channel. A three beep tone will sound if an invalid channel is selected.

To place an All Ships Call . . .

Press the   keys. The DSC CALLING menu will appear in the display.

Press the  key repeatedly until ALL SHIPS menu appears.

Press the  or  keys to select the priority for the call.

Press the  key to initiate the All Ships Call. DSC transceivers aboard vessels receiving the call will ring and ALL SHIPS will appear their display.

The vessel initiating the All Ships call should make a voice call to alert the other vessels.

Send Position

The Send Position function allows your vessel's position coordinates to be sent to another vessel as a DSC call, thereby avoiding a voice announcement of your position. Position information is obtained from an operating navigation receiver properly connected to the data interface.

The Send Position function will override the POSITION XMIT DISABLE User Option in the User Setups mode. The type of position coordinates sent, either Lat./Lon or Loran TD's, is determined by the POSITION TYPE User Option in the User Setups mode. Also affecting the type of coordinates sent is the operating mode of the navigation receiver. Some Loran receivers do not output both Lat./Lon and TD's simultaneously. If the operating mode of the Loran and the POSITION TYPE User Option do not agree, your position may not be sent.



NOTE

Transmitting and receiving Loran TD position coordinates is a proprietary feature of the DSC 500. Other manufacturers are not required to support this feature and may not accept Loran TD'S.

To send your position . . .

Press the   keys. The DSC CALLING menu will appear in the display.

Press the  key repeatedly until the SEND POSITION menu appears.

Press the  or  key to select the desired name from the directory.

Press the  key to initiate the call. There is no acknowledgement from the other vessel that the position coordinates were received.

Receiving a Position

When a Send Position call is received from another vessel, four beeps will sound and RCV POSITION will appear in the upper line of the display.

The calling Vessel's name or Ship Station Identity number will appear in the second line and the calling Vessel's coordinates will appear in the lower two lines of the display.

At the same time as the position coordinates are displayed, the position information is output through the data interface. The interface may be connected to any device capable of receiving the information.

If the receiving device was not ready to accept the data . . .

Press the  key. Each time the key is pressed, the position coordinates will be output to the data interface.

The display will remain until a valid channel number is entered or the Push to Talk button is pressed or another function is selected.

Request Position



The Request Position function allows you to interrogate another vessel to determine its position coordinates. The other vessel must have an operating navigation receiver connected to its DSC transceiver and must not have its transceiver set to deny position requests.

The DSC 500 allows the user to deny position requests by a User Options setting in the User Setups mode. Presumably other manufacturers of DSC equipment would offer an equivalent setting.

To request the position of another vessel . . .

Press the   keys. The DSC CALLING menu will appear in the display.

Press the  key repeatedly until the REQ POSITION menu appears.

Press the  or  key to select the desired name from the directory.

Press the  key to initiate the call. The called Vessel's name and WAITING will appear in the display. Three or four beeps will sound and either the called Vessel's coordinates or a status message will appear in the display.

If the called Vessel's coordinates appear . . .

At the same time as the position coordinates are displayed, the position information is output through the data interface. The interface may be connected to any device capable of receiving the information.

If the receiving device was not ready to accept the data . . .

Press the  key. Each time the key is pressed, the position coordinates will be output to the data interface.

To return to the Request Position menu . . .

Press the  key.

To return to the Primary mode . . .

Enter a valid channel number or press the Push to Talk button or select another mode by pressing the appropriate function keys.

Status messages are . . .

NO POSITION AVAILABLE. Contact with the called vessel was established but a position was not reported, either because the request was denied or position data was not available from a navigation receiver.

To return to the Request Position menu . . .

Press the **CLR** key.

NO RESPONSE. Contact with the other vessel could not be established. After several seconds, the directory will reappear with the called Party's name at the top of the list. You may call again later or select another party to call.

DSC Auto Polling

DSC Auto Polling provides a means of requesting the position of all vessels listed in the calling Vessel's DSC Calling directory. Auto Polling is an optional feature of the DSC 500 requiring factory installed programming. Polling intervals from 15 seconds to 5 minutes may be selected. Normal communication is impractical when Auto Polling on short intervals is active.

The polling sequence begins 60 seconds after a polling interval has been selected from the User Options page of the User Setups menu. Once selected, polling continues even if the transceiver is turned Off and back On again.

To poll other vessels . . .

Press the **SET** key. The USER SETUP menu will appear in the display.

See procedures for selecting User Options from the User Setups menu elsewhere in this manual.

To return to the Primary mode . . .

Select a non-polling option from the User Options page of the User Setups menu.

See procedures for selecting User Options from the User Setups menu elsewhere in this manual.

Local and Distant Receiver Modes

This radio has been specially designed to withstand high levels of interference from land-based high-power transmitters operating in the VHF band. For optimum performance in congested areas, please operate the unit in LOCAL RCVR mode. Then, while at sea, you may operate the unit in DISTANT RCVR mode, which will give you the ultimate radio range performance. If for some reason, you are unable to toggle the radio between the two settings, we must suggest that you leave the unit in the LOCAL RCVR mode as that will insure adequate performance in all conditions.

To toggle between these two modes, press the **FNC** key, then **1**, followed by the . Press the **ENT** key after the desired mode has been selected.

The LOCAL RCVR mode will be annunciated with a flashing "L" in the bottom right of the display. There will be no indication of the DISTANT RCVR mode as it is considered to be a normal function of the radio.

REFERENCE

Operating Techniques

Your ROSS DSC 500 transceiver is easy to use and very reliable. The increasing popularity of such equipment has led to areas where the airwaves are very crowded. The use of professional radio technique when you are transmitting will help to reduce the channel congestion. Below are listed a few rules of thumb which will help everyone using marine VHF:

1. Listen before you transmit. Insure that you will not interfere with traffic already in progress on the channel.
2. Give absolute priority to distress calls. Continue to listen, but do not transmit in response to a distress call unless you are in a position to help.
3. Agree on an appropriate working channel and switch to that channel as soon as you have established contact on channel 16. Your calls on channel 16 should be less than 30 seconds long.
4. Keep your transmissions as short as possible and still get your message across.
5. If you don't get a response to your call, wait 2 minutes before calling again.
6. Use professional phraseology and the phonetic alphabet when necessary.

Maintenance

Your ROSS DSC 500 has been designed to withstand the rigors of the marine environment, but a little care will provide added protection from the elements. The transceiver case is watertight but should not be directly "washed down" with running water. Salt water residue should be removed with a damp sponge or cloth and then the unit dried with a paper towel.

General cleaning may be done with a light spray of liquid window cleaner followed by drying with a paper towel. A wipe down with CRC formula 6-66 will help the transceiver shed water when splashed.

The electrical connectors may be sprayed with CRC 6-66 to prevent corrosion.

The face of the display will perform best when kept free of all foreign matter. Gently wipe the display with a soft paper towel moistened with isopropyl alcohol or liquid window cleaner. Please do not use excessive pressure, which could scratch or break the glass.

Memory Battery

The ROSS DSC 500's memory is protected with an internal Lithium battery that should last approximately 5 years. An indication of battery failure is when any one of four memory related messages appears in the display following Self Test. On rare occasions, a Memory Failed message could appear without there being a battery failure.

MEMORY FAILED will appear on the upper line of the display and either RADIO SETUPS, DSC CALLING, TELEPHONE or CALL WAITING will appear in the second line of the display to indicate the area of difficulty. Also, appearing in the lower two lines of the display are prompts for how to proceed.

The choices are:

Press the CLR key to clear the memory or . . .

Press the ENT key to proceed without clearing the memory.

Pressing the ENT key would be the conservative choice. Then, examine the directories for errors. If the directories are in order, continue normal usage of the transceiver. The error message was the result of a random glitch.

When the battery fails, all directories and memory channels will be lost and the ROSS DSC 500 must be returned to the factory or an authorized repair facility for battery replacement.

Fault Code Display

If a malfunction should occur in the DSC 500 that would cause the transceiver to be off frequency, SYNTHESIZER LOCK FAILURE will appear in the display and the DSC 500 will not transmit when the Push-to-Talk button is pressed. Low battery voltage or undersize power wiring may cause this. If the condition persists, factory service is required.

Antenna Fault

ANT FAULT will appear in the Primary mode display if a high VSWR condition is detected while transmitting. Loose, corroded or wet antenna connectors, damaged antenna cable or a defective antenna, may cause this condition.

If ANT FAULT appears, visually inspect the antenna and the antenna cable for signs of damage or moisture intrusion. Also, clean and tighten the antenna connectors. If these efforts do not clear the fault, professional help is needed. Please seek the services of a licensed technician to correct the difficulty.

Simplex and Duplex Channels

The transmitter frequency for any particular channel is the same in both the USA and the International frequency sets. But the receiver frequency on some channels is not the same as the transmitter frequency. Channels where both transmitter and receiver are on the same frequency are known as simplex channels. Duplex channels are those where the transmitter is on one frequency and the receiver is on another. In the marine VHF service, the receiver is 4.6 MHz higher than the transmitter on duplex channels.

The International frequency set has more duplex channels and the USA set has more simplex channels. There are some differences in the intended use for certain channels too. Also worth noting, any simplex International channel has a corresponding simplex channel in the USA set. The reverse is not true however, many simplex USA channels correspond to duplex International channels.

Vessel to vessel communication on corresponding simplex channels using either USA or International frequencies is possible because both transmitters and receivers are on the same frequency. However, if communication is attempted between vessels on a duplex channel, neither will hear the other since they are both transmitting on one frequency and listening on another. A more confusing situation develops if vessels attempt communication when one is on International frequencies, the other is on USA frequencies and the channel is duplex for one and simplex for the other. Duplex channels are intended for ship to coast communication where the coast station transmits on the corresponding receiving frequency for the vessel.

Data Communications Interface

Data Communication capability is provided in the DSC 500 so that it may report your vessel's position coordinates as obtained from a navigation receiver such as Loran-C or GPS. Also, the data interface allows position coordinates received from another vessel, by your DSC 500, to be sent to a compatible navigation receiver as a waypoint. A bi-directional data interface is required to take full advantage of this capability. Most modern navigation receivers have a data output that sends position coordinates to other equipment while few have data input capability to receive coordinates from other equipment.

A standard developed by the National Marine Electronics Association and used by most marine equipment manufacturers for data communication is known as NMEA 0183. NMEA 0183 specifications offer many standard 'sentences' for exchanging data between various types of marine equipment. The sentences used by the DSC 500 are described below. Not all of the information contained in the sentences is used, however. The sentences containing position coordinates are used for position reporting but other sentences are only monitored to obtain status information to assure the validity of the position data.

Consult the operator's manual for the navigation equipment that you want to connect to your DSC 500 for the sentence that it sends or expects to receive.

THE ELECTRICAL CONNECTION FOR THE DATA INTERFACE IS DESCRIBED IN THE INSTALLATION section.

NMEA 0183 Sentences Supported

The following tables list the sentences supported by the DSC 500 and the navigation data available in each sentence.

Listen Sentences:

Sentence ID	Information Provided
\$xxGGA	UTC time, Lat./Lon, Satellite data.
\$xxGLL	Geographical position in Lat./Lon.
\$xxGTD	Loran-C position in TD'S.
\$xxAPA	Status, Cross Track Error, Steer L/R, Arrival and Perp. crossing Alarm, Mag. Bearing from Origin Wpt. to Dest. Wpt.
\$xxRMA	Status, Lat./Lon position, SOG, COG, Mag. Var.
\$xxRMB	Cross Track Error, Steer L/R, Origin Wpt. Ident., Dest. Wpt. Ident., Dest. Wpt. L/L, Bearing and Distance and Speed to Wpt., Arrival and Perp. cross Alarm.
\$GPRMC	UTC Time, Status, Lat./Lon position, SOG, COG, Date, Mag. Var.
\$xxVTG	Track Made Good, Ground Speed (COG and SOG).
\$PKMLC	Loran-C position, TD'S or Lat./Lon (King).
\$PKMAP	Status, Cyc. Lock, Cross Track Error, Steer L/R, Wpt. Ident., Distance to Wpt., Arrival and Perp. cross Alarm (King).

The characters xx, in the ID field, indicate that data will be accepted from any type of device sending the sentence.

Talk Sentences:

\$xxBWC UTC time, Bearing & Distance (great circle) to Waypoint.

\$CDWPL Normal waypoint coordinates, Lat./Lon, Wpt. Ident.

\$PREWPT Waypoint coordinates, TD'S, Wpt. Ident. (Ross).

\$PRERV Track Made Good, Ground Speed, DSC Ident. Number.

NMEA 0183 Specifications

The following technical information is provided for reference and is accurate to the best of our knowledge at the time of printing. Please refer to the appropriate NMEA specifications for full details and the latest information. *Refer to NMEA 0183-1997*

Baud rate	4800
Data bits	8
Parity	None
Stop bits	2
Character Code	ASCII
Voltage Level	0-5V

Sentence recurrence rate: 2 seconds.

Refer to NMEA 0183-1997

\$PKMLC,0,XXXXX.x,XXXXX.x[CR][LF]

| | | | |
| | | | | Sentence Terminator.

| | | | | TD.

| | | | | TD.

| | | | | Position Mode ID: 0 = TD Format.

| | | | | Address: Talker ID & Format, LC = Loran-C.

Start of Sentence Symbol. PKM = King Proprietary.

\$PKMLC,1,DDMM.mm,H,DDDMM.mm,H[CR][LF]

| | | | | | | | | |
| | | | | | | | | | Sentence Terminator.

| | | | | | | | | | Hemisphere: E, W.

| | | | | | | | | | Longitude: Degrees, Minutes, Hundredths of minutes.

| | | | | | | | | | Hemisphere: N, S.

| | | | | | | | | | Latitude: Degrees, Minutes, Hundredths of minutes.

| | | | | | | | | | Position Mode ID: 1 = Lat./Lon.

| | | | | | | | | | Address: Talker ID & Format, LC = Loran-C.

Start of Sentence Symbol. PKM = King Proprietary.

\$LCAPB** and

\$PKMAP,A,A,X.XX,N,L,XX,ddd,rrr.rr,V,V[CR][LF]

| | | | | | | | | | | | | | | |
| | | | | | | | | | | | | | | | Sentence Terminator.

| | | | | | | | | | | | | | | | Perpendicular Crossing Alarm,

| | | | | | | | | | | | | | | | V = Not Set / Not Crossed.

| | | | | | | | | | | | | | | | A = Alarm Set / Crossed.

| | | | | | | | | | | | | | | | Arrival Alarm, V = Not Set, A = Alarm Set.

| | | | | | | | | | | | | | | | Distance to Waypoint (999.99 max.).

| | | | | | | | | | | | | | | | Magnetic Bearing to Destination Waypoint.

| | | | | | | | | | | | | | | | Destination Waypoint Number.

| | | | | | | | | | | | | | | | Direction to Steer, L = Left, R = Right, back to course.

| | | | | | | | | | | | | | | | Distance Units, N = Nautical Miles, K = Kilometers.

| | | | | | | | | | | | | | | | Cross Track Error (distance off course 9.99 max.).

| | | | | | | | | | | | | | | | Cycle Lock: A = Valid, V = Invalid.

| | | | | | | | | | | | | | | | Or'ed Blink and SNR: A = Valid, V = Invalid.

| | | | | | | | | | | | | | | | Address: Talker ID & Format, PK = King proprietary.

Start of Sentence. MAP = Autopilot.

** \$LCAPB when used in some King products is a King proprietary sentence which has a different format than the NMEA standard \$LCAPB Autopilot Format B sentence.

Table 1

USA VHF MARINE CHANNEL ASSIGNMENTS

Channel Number	Channel Assignment	Receive Freq. (MHz)	Transmit Freq. (MHz)
01	PORT OPERATIONS	156.050	156.050
02	PORT OPERATIONS	156.100	156.100
03	INTERSHIP & COAST-COAST	156.150	156.150
04	PORT OPERATIONS	156.200	156.200
05	PORT OPERATIONS (Intership/Ship-Coast)	156.250	156.250
06	SHIP TO SHIP SAFETY ONLY	156.300	156.300
07	COMMERCIAL (Intership/Ship-Coast)	156.350	156.350
08	COMMERCIAL (Intership)	156.400	156.400
09	COMMERCIAL & NON COMMERCIAL (Intership/Ship-Coast)	156.450	156.450
10	COMMERCIAL (Intership/Ship-Coast)	156.500	156.500
11	COMMERCIAL (Intership/Ship-Coast)	156.550	156.550
12	PORT OPERATIONS (Intership/Ship-Coast)	156.600	156.600
13	NAVIGATION (Ship to Ship)	156.650	156.650 +*
14	PORT OPERATIONS (Intership/Ship-Coast)	156.700	156.700
15	ENVIRONMENTAL	156.750	156.750 *
16	DISTRESS, SAFETY, AND CALLING (Intership/Ship-Coast)	156.800	156.800
17	STATE CONTROL	156.850	156.850 *
18	COMMERCIAL (Intership/Ship-Coast)	156.900	156.900
19	COMMERCIAL (Intership/Ship-Coast)	156.950	156.950
20	PORT OPERATIONS (Intership/Ship-Coast)	161.600	157.000
21	U.S. GOVERNMENT ONLY	157.050	157.050
22	COAST GUARD LIAISON	157.100	157.100
23	U.S. GOVERNMENT ONLY	157.150	157.150
24	PUBLIC CORRESPONDENCE (Ship-Coast)	161.800	157.200
25	PUBLIC CORRESPONDENCE (Ship-Coast)	161.850	157.250
26	PUBLIC CORRESPONDENCE (Ship-Coast)	161.900	157.300
27	PUBLIC CORRESPONDENCE (Ship-Coast)	161.950	157.350

TABLE 1

USA VHF MARINE CHANNEL ASSIGNMENTS (CONT'D)

Channel Number	Channel Assignment	Receive Freq. (MHz)	Transmit Freq. (MHz)
28	PUBLIC CORRESPONDENCE (Ship-Coast)	162.000	157.400
60	-	160.625	156.025
61	-	160.675	156.075
62	PUBLIC CORRESPONDENCE	160.725	156.125
63	PORT OPERATIONS	156.175	156.175
64	-	160.825	156.225
65	PORT OPERATIONS (Intership and Ship-Coast)	156.275	156.275
66	PORT OPERATIONS (Intership and Ship-Coast)	156.325	156.325
67	COMMERCIAL MISS. RIVER	156.375	156.375 +*
68	NON-COMMERCIAL	156.425	156.425
69	NON-COMMERCIAL	156.475	156.475
70	DIGITAL SELECTIVE CALLING (do not use as working channel)	156.525	156.525 **
71	NON-COMMERCIAL	156.575	156.575
72	NON-COMMERCIAL	156.625	156.625
73	PORT OPERATIONS (Intership/Ship-Coast)	156.675	156.675
74	PORT OPERATIONS (Intership/Ship-Coast)	156.725	156.725
75	GUARD CHANNEL	156.775	156.775 *
76	GUARD CHANNEL	156.825	156.825 *
77	PORT OPERATIONS (Intership)	156.875	156.875
78	NON-COMMERCIAL	156.925	156.925
79	COMMERCIAL (Intership/Ship-Coast)	156.975	156.975
80	COMMERCIAL (Intership/Ship-Coast)	157.025	157.025
81	U.S. GOVERNMENT ONLY	157.075	157.075
82	U.S. GOVERNMENT ONLY	157.125	157.125
83	U.S. GOVERNMENT ONLY	157.175	157.175
84	PUBLIC CORRESPONDENCE (Ship-Coast)	161.825	157.225
85	PUBLIC CORRESPONDENCE (Ship-Coast)	161.875	157.275
86	PUBLIC CORRESPONDENCE (Ship-Coast)	161.925	157.325
87	PUBLIC CORRESPONDENCE (Ship-Coast)	161.975	157.375
88	COMMERCIAL (Intership)	157.425	157.425

* 1 Watt default, 25 Watts selectable.

+* 1 Watt except 25 Watts with manual override on (Ch 13 and Ch 67).

** Transmitter disabled except for DSC calling.

Table 2

INTERNATIONAL VHF MARINE CHANNEL ASSIGNMENTS

Channel Number	Channel Assignment	Receive Freq. (MHz)	Transmit Freq. (MHz)
01	PORT OPERATIONS	160.650	156.050
02	PORT OPERATIONS	160.700	156.100
03	PUBLIC CORRESPONDENCE	160.750	156.150
04	PORT OPERATIONS	160.800	156.200
05	PORT OPERATIONS	160.850	156.250
06	INTERSHIP SAFETY	156.300	156.300
07	PUBLIC CORRESPONDENCE	160.950	156.350
08	COMMERCIAL	156.400	156.400
09	PORT OPERATIONS	156.450	156.450
10	PORT OPERATIONS	156.500	156.500
11	PORT OPERATIONS	156.550	156.550
12	PORT OPERATIONS	156.600	156.600
13	PORT OPERATIONS	156.650	156.650 +*
14	PORT OPERATIONS	156.700	156.700
15	ON-BOARD COMMUNICATIONS	156.750	156.750 *
16	DISTRESS SAFETY & CALLING	156.800	156.800
17	ON-BOARD COMMUNICATIONS	156.850	156.850 *
18	PORT OPERATIONS	161.500	156.900
19	PORT OPERATIONS	161.550	156.950
20	PORT OPERATIONS	161.600	157.000
21	PORT OPERATIONS	161.650	157.050
22	PORT OPERATIONS	161.700	157.100
23	PUBLIC CORRESPONDENCE	161.750	157.150
24	PUBLIC CORRESPONDENCE	161.800	157.200
25	PUBLIC CORRESPONDENCE	161.850	157.250
26	PUBLIC CORRESPONDENCE	161.900	157.300
27	PUBLIC CORRESPONDENCE	161.950	157.350
28	PUBLIC CORRESPONDENCE	162.000	157.400
60	PORT OPERATIONS	160.625	156.025
61	PORT OPERATIONS	160.675	156.075
62	PUBLIC CORRESPONDENCE	160.725	156.125
63	PORT OPERATIONS	160.775	156.175
64	-	160.825	156.225
65	SPECIAL EMERGENCY	160.875	156.275
66	-	160.925	156.325
67	PORT OPERATIONS	156.375	156.375 +*
68	PORT OPERATIONS	156.425	156.425
69	PORT OPERATIONS	156.475	156.475
70	DIGITAL SELECTIVE CALLING (Do not use as working channel)	156.525	156.525 **
71	PORT OPERATIONS	156.575	156.575
72	COMMERCIAL	156.625	156.625
73	PORT OPERATIONS	156.675	156.675
74	PORT OPERATIONS	156.725	156.725

Table 2

INTERNATIONAL VHF MARINE CHANNEL ASSIGNMENTS (CONT'D)

Channel Number	Channel Assignment	Receive Freq. (MHz)	Transmit Freq. (MHz)
75	-	156.775	156.775 *
76	-	156.825	156.825 *
77	COMMERCIAL	156.875	156.875
78	PORT OPERATIONS	161.525	156.925
79	PORT OPERATIONS	161.575	156.975
80	PORT OPERATIONS	161.625	157.025
81	PORT OPERATIONS	161.675	157.075
82	PORT OPERATIONS	161.725	157.125
83	PUBLIC CORRESPONDENCE	161.775	157.175
84	PUBLIC CORRESPONDENCE	161.825	157.225
85	PUBLIC CORRESPONDENCE	161.875	157.275
86	PUBLIC CORRESPONDENCE	161.925	157.325
87	PUBLIC CORRESPONDENCE	161.975	157.375
88	PUBLIC CORRESPONDENCE	162.025	157.425

* 1 Watt default, 25 Watts selectable.

+* 1 Watt except 25 Watts with manual override on (Ch 13 and Ch 67).

** Transmitter disabled except for DSC calling.

Table 3

VHF MARINE WEATHER CHANNEL ASSIGNMENTS

RECEIVE ONLY

Channel Number	Channel Assignment	Receive Freq. (MHz)
WX0	-	163.275
WX1	NOAA WEATHER	162.550
WX2	NOAA WEATHER	162.400
WX3	NOAA WEATHER	162.475
WX4	NOAA WEATHER	162.425
WX5	NOAA WEATHER	162.450
WX6	-	162.500
WX7	-	162.525
WX8	CANADIAN WEATHER	161.650
WX9	-	161.775

